

Mississippi State University

Scholars Junction

Theses and Dissertations

Theses and Dissertations

8-2-2003

Chemically Deposited Optical Fiber Humidity Sensor

Parikshit S. Gaikwad

Follow this and additional works at: <https://scholarsjunction.msstate.edu/td>

Recommended Citation

Gaikwad, Parikshit S., "Chemically Deposited Optical Fiber Humidity Sensor" (2003). *Theses and Dissertations*. 1053.

<https://scholarsjunction.msstate.edu/td/1053>

This Graduate Thesis - Open Access is brought to you for free and open access by the Theses and Dissertations at Scholars Junction. It has been accepted for inclusion in Theses and Dissertations by an authorized administrator of Scholars Junction. For more information, please contact scholcomm@msstate.libanswers.com.

CHEMICALLY DEPOSITED OPTICAL FIBER HUMIDITY SENSOR

By

Parikshit Gaikwad

A Thesis
Submitted to the Faculty of
Mississippi State University
in Partial Fulfillment of the Requirements
for the degree of Master of Science
in Electrical Engineering
in the Department of Electrical and Computer Engineering

Mississippi State, Mississippi

August 2003

CHEMICALLY DEPOSITED OPTICAL FIBER HUMIDITY SENSOR

By

Parikshit Gaikwad

Approved:

Randolph Follett
Assistant Professor of Electrical and
Computer Engineering
(Major Professor, Co-Director of Thesis)

Jagdish P. Singh
Senior Research Scientist
Diagnostic Instrumentation and Analysis
Laboratory (DIAL)
(Co-Director of Thesis, Committee
Member)

Nicholas H. Younan
Professor and Electrical Engineering
(Graduate Program Director and
Committee Member)

A. Wayne Bennett
Dean of the College of
Engineering

Name: Parikshit Gaikwad

Date of Degree: August 2, 2003

Institution: Mississippi State University

Major Field: Electrical Engineering

Major Professor: Dr. Randolph Follett

Title of Study: CHEMICALLY DEPOSITED OPTICAL FIBER HUMIDITY SENSOR

Pages in Study: 66

Candidate for Degree of Master of Science

Humidity measurement in industries is a critical factor, since it may affect the business cost of the product, end product quality, optimal functioning of equipment, and the health and safety of the personnel. Hence, humidity sensing is becoming very important, especially in the control systems for industrial processes. Since humidity is expressed in different ways, it is very difficult to come up with a reliable, consistent, and repeatable humidity measurement approach. In contrast to other sensors employed for measuring other parameters like temperature and pressure, a humidity sensor has to be in contact with the process environment and hence is difficult to implement. This research was initiated at the Diagnostic Instrumentation and Analysis Laboratory (DIAL) for the requirement from the DOE to monitor the moisture in the soil at the nuclear waste storage facility. The idea was to monitor the leakage, if any, in the storage cylinders to avoid any hazard that may come up. The humidity sensor in this case had to be able to transmit the measurement over a distance far away from the actual measurement site. Keeping all these factors in mind, a chemically deposited optical fiber humidity sensor was

developed. It was based on the evanescent tail absorption of light passing through an optical fiber due to hygroscopic material deposited on it. The hygroscopic material used was an aqueous solution of Poly-vinyl-acetate (PVA) and Cobalt Chloride (CoCl_2). The sensor yielded a consistent humidity measurement from 75% to 95%. Based on the above research, research is currently in progress to bring up a commercial prototype of the sensor.

DEDICATION

I dedicate this thesis to my inspiration Mummy – Bapu (Mom – Dad) and my support, Radhika.

ACKNOWLEDGEMENTS

I would like to take this opportunity to express my gratitude towards Dr. Randolph Follett for agreeing to be the major professor and the co-director of my thesis. I would like to thank Dr. J. P. Singh to have served as co-director of my thesis and Dr. Nicholas H. Younan for serving as committee member of this thesis.

I would like to thank Dr. Rajeev Jindal for his guidance, patience and technical support throughout my thesis work.

TABLE OF CONTENTS

	Page
DEDICATION	ii
ACKNOWLEDGEMENTS	iii
TABLE OF CONTENTS	iv
LIST OF TABLES	vi
LIST OF FIGURES	vii
CHAPTER	
I HUMIDITY: AN OVERVIEW	1
1.1 Introduction	1
1.2 Keywords, Concepts, and Definitions for Humidity	2
1.3 Literature Survey	6
1.3.1 Mechanical	6
1.3.2 Wet- and dry-bulb psychrometer	7
1.3.3 Resistive Sensors	9
1.3.3a Ceramic Sensors	9
1.3.3b Polyelectrolyte Sensors	11
1.3.4 Capacitive Sensors	12
1.3.5 Digital Hygrometer	13
1.3.6 Polymer Dielectric Sensors [2]	14
1.3.7 A High-Speed Capacitive Humidity sensor [6]	15
1.3.8 Spectroscopic	16
1.3.9 Color Change	17
1.3.10 Acoustic	17
1.3.11 Piezoelectric	17
1.3.12 Thermal conductivity	17
1.4 Need of Fiber Optic Humidity Sensors	18
1.4.1 Fiber Optic Sensor Technology: Introduction and Background	18
1.4.2 Fiber optic humidity sensor based on a mechanical phenomenon	20
1.4.3 Fiber Optic Humidity Sensor based on a Chemical phenomenon	21

CHAPTER	Page
II CURRENT APPROACH: HYDRO-GEL DEPOSITED FIBER OPTIC HUMIDITY SENSOR.....	22
2.1 Principle.....	22
2.2 Background.....	23
2.3 Theory and Experimental Set-up.....	24
2.4 Sensor Construction.....	25
2.5 PC-based Online Data Acquisition System.....	26
2.6 Sensor Operation and Experimental Procedure.....	27
2.7 Results and Discussion.....	28
2.8 Conclusion and Summary.....	36
III A CHEMICALLY DEPOSITED OPTICAL FIBER HUMIDITY SENSOR.....	38
3.1 Introduction.....	38
3.2 Working Principle.....	38
3.3 Background and Results.....	41
3.4 Experimental Set-up.....	43
3.4.1 Sensor Construction.....	43
3.4.2 Climate Chamber.....	43
3.5 Experimental Procedure –Results and Discussion.....	45
3.6 Conclusion.....	54
IV CURRENT DEVELOPMENTS AND FUTURE WORK.....	56
4.1 Introduction.....	56
4.2 U-shaped Sensing Probe Optical Fiber Humidity Sensor.....	56
4.3 Theory.....	57
4.4 U-shaped Sensor Probe Implementation and Current Development.....	59
4.5 Acknowledgement.....	60
REFERENCES.....	61
APPENDIX.....	62
A. GRAPHICAL USER INTERFACE FOR THE PC-BASED ONLINE DATA ACQUISITION SYSTEM IN LABVIEW.....	62
B. OPTICAL FIBER POLISHING METHOD.....	66

LIST OF TABLES

TABLE		Page
1	Various humidity sensing approaches and their operation mechanism	5
2.1	Hydro-gel Based fiber optic humidity Sensor Response (manual readings) ...	29
2.2	Hydro-gel Based fiber optic humidity Sensor Response (manual readings, power output)	30
2.3	Hydro-gel Based fiber optic humidity Sensor Response (manual readings)(B)	31
3.1	Key development details and specifications of the sensor.....	56

LIST OF FIGURES

FIGURE	Page
1.1 Wet and dry-bulb psychrometer.....	7
1.2 Relative humidity and dry-bulb temperature psychrometric graph	8
1.3 Typical Resistive Humidity Sensor	10
1.4 Typical Capacitive Humidity Sensor	12
1.5 Digital Hygrometer [9]	14
1.6 High-speed capacitive humidity sensor	16
2.1 Microbending in an Optical Fiber.....	23
2.2 Design of the Sensor	26
2.3 Hydro-gel Based fiber optic humidity Sensor Response (manual readings) (A)	29
2.4 Figure 2.4 Hydro-gel Based fiber optic humidity Sensor Response (manual readings, power output)	31
2.5 Hydro-gel Based Fiber Optic humidity Sensor Response (Manual Readings) (B).....	32
2.6 Hydro-gel based fiber optic Humidity Sensor Response (with moisture introduced, bends at 2mm).....	33
2.7 Hydro-gel based fiber optic Humidity Sensor Response (with moisture removed, bends at 2mm).....	34
2.8 Hydro-gel deposited Fiber Optic Moisture Sensor Characteristics (bends at 2mm	35
2.9 Hydro-gel deposited Fiber Optic Moisture Sensor Characteristics (bends at 1mm).....	36

FIGURE	Page
3.1 Evanescent Tail Absorption.....	39
3.2 Transmission Spectra Measured on a Cobalt Chloride (CoCl ₂)-treated Optical Fiber Saturated by Moisture (A) and Dried by Air (B) [17].....	40
3.3 Experimental set-up	45
3.4 Standard probe and Fiber Optic humidity Sensor Response	47
3.5 Standard probe and Fiber Optic humidity Sensor Response (B)	48
3.6 Standard probe and Fiber Optic humidity Sensor Response(C)	49
3.7 Modified Experimental set-up	50
3.8 Standard probe and Fiber Optic humidity Sensor Response (Modified Set-up).....	51
3.9 Standard probe and Fiber Optic humidity Sensor Response (Step Changes)..	52
3.10 Standard probe and Fiber Optic humidity Sensor Response (Cladding removed by acetone- no coats)	53
3.11 Standard probe and Fiber Optic humidity Sensor Response (Cladding removed by burning-no coats)	54
3.12 Standard probe and Fiber Optic humidity Sensor Response (Cladding removed by burning).....	55
4.1 Straight Probe Sensor, Light Path and Its Interaction With the Core-cladding Interface.....	58
4.2 U-shaped (bent) Probe Sensor, Light Path and Its Interaction with the Core-cladding Interface	59
4.3 The implemented U-shaped (bent) Probe Sensor	60
4.4 Standard probe and bent probe humidity sensor response.....	61

CHAPTER I

HUMIDITY: AN OVERVIEW

1.1 Introduction

Humidity is the presence of water in air. The amount of water vapor in air can affect human comfort as well as many manufacturing processes in industries. The presence of water vapor also influences various physical, chemical, and biological processes [1]. Humidity measurement in industries is critical because it may affect the business cost of the product and the health and safety of the personnel. Hence, humidity sensing is becoming very important, especially in the control systems for industrial processes and human comfort. Since humidity is expressed in different ways, it is very difficult to come up with a reliable, consistent, and repeatable humidity measurement approach. In contrast to other sensors employed for measuring other parameters like temperature and pressure, a humidity sensor has to be in contact with the process environment and hence is difficult to implement.

Some of the reasons that explain the importance and need of humidity measurement are listed below [2]:

1. In many industrial processes, the end product quality depends on controlling the humidity of the surrounding environment.

2. Human health, production rate, and comfort are adversely affected by extremely humid conditions.
3. Humidity sensing and control are important in optimal functioning of most home appliances.
4. The discharge of electrostatic energy that accumulates in solid-state electronic equipment because of a dry environment needs the humidity control in order to assure optimal functioning of the instruments.

Many processes in production and manufacturing industries require humidity measurement. The increasing importance of measuring humidity has caused researchers to search for more reliable and cost-effective humidity sensors and related control systems. There have been many approaches carried out in order to come up with a feasible humidity measurement technique. This section deals with the basic concepts in humidity and the various approaches and developments carried out in this field.

1.2 Keywords, Concepts, and Definitions for Humidity

This section discusses the basic concepts and definitions related to humidity measurement. These are the keywords in humidity measurement [2].

Humidity: It is the presence of water in air or another gas. Air (or any other gas) has a property of absorbing water vapor, which depends mainly on the temperature. This is the basic reason why humidity arises. The air that has maximum water vapor content is called “saturated air”. One of the various ways of expressing humidity is the “relative

humidity”, which expresses how fully saturated the gas is with the water vapor. Another way of expressing humidity is the “absolute humidity”, which is a measure of actual water vapor present without the consideration of the temperature and saturation point of the gas. The definitions of these terms are mentioned in this section of the chapter further. The term humidity broadly expresses the absolute indication or absolute value of humidity except for lower humidity values, where more specific terms are used.

Relative humidity: In an air-water mixture, it is the ratio of partial water vapor pressure to the saturation vapor pressure of water at the same temperature. In other words, the relative humidity is the ratio of the actual amount of moisture in the atmosphere to the amount of moisture the atmosphere can hold. Therefore, a relative humidity of 100% means the air can hold no more water (rain or dew is likely), and a relative humidity of 0% indicates there is no moisture in the atmosphere.

Absolute humidity: The mass of water vapor in a given volume of air; i.e. density of water vapor in a given sample, usually expressed in grams per cubic meter.

Specific humidity: The mass of water vapor in a parcel divided by the total mass of the air in the parcel (including water vapor). It can be also defined as the mass of water vapor per unit mass of humid air.

Dew point: The temperature to which air would have to be cooled in order for saturation to occur. The dew point temperature assumes there is no change in air pressure or moisture content of the air.

Dry-bulb temperature: The air temperature (usually paired with wet-bulb for measurement) that is used to derive the relative humidity.

Wet-bulb temperature: The lowest temperature that can be obtained by evaporating water into the air at a constant pressure. The name comes from the technique of putting a wet cloth over the bulb of a mercury thermometer and then blowing air over the cloth until the water evaporates. Since evaporation takes up heat, the thermometer will cool to a lower temperature than a thermometer with a dry bulb at the same time and place. Wet-bulb temperatures can be used along with the dry-bulb temperature to calculate the dew point or relative humidity.

Saturation of air: The condition under which the amount of water vapor in the air is the maximum possible at the existing temperature and pressure. Condensation will begin if the temperature falls or water vapor is added to the air.

Actual vapor pressure: The partial pressure exerted by the water vapor present in a parcel. Water in a gaseous state (i.e. water vapor) exerts a pressure just like the atmospheric air. Vapor pressure is also measured in mill bars.

Saturation vapor pressure: The maximum partial pressure that water vapor molecules would exert if the air were saturated with vapor at a given temperature. The saturation vapor pressure is directly proportional to the temperature. In other words, it is the maximum pressure of water that can exist at a given temperature.

Moisture Content: This is one more term that expresses humidity, which is usually used for the general description. It also refers to the proportion of water present in liquids or solids.

Hygrometry: The subject of humidity measurement.

Hygrometer: Any instruments measuring humidity.

This chapter also discusses the various approaches carried out before in order to develop a humidity sensor. Some of the types of humidity sensors and their working principles are tabulated below [2].

Table 1
Various humidity sensing approaches and their operation mechanisms

Principle	Operating Mechanism
Capacitance	The dielectric constant of the material varies with the amount of water absorbed.
Coulometric	An electrolyte is formed by absorption of water and the current level obtained is proportional to the moisture content.
Dew Point	The temperature corresponding to the condensation-evaporation equilibrium at a cooled surface varies with the amount of water present.
Gravimetric	A volume of moist air is exposed to a drying agent and subsequently weighed. The weight corresponds to the moisture.
Infra-red	The amount of absorption between the infrared range (1.5 to 1.93 μ m), which is computed for a reference cell and then for the sample cell.
Microwave	The radiation at the receiving end attenuates as the amount of water content increases.
Psychrometric	The introduction of humid air on the wet-bulb evaporation cools the wet bulb and the temperature is measured. The temperature change varies with the amount of water present in the humid air introduced.
Radio-frequency sensor	Radio-frequency current produced due to the dielectric change is a function of moisture content.
Resistance	The conductivity of the resistor depends on the amount of water absorbed.
Thermal conductivity	Self-heated thermistors are connected in a whetstone's bridge circuit. Due to the moisture present, there is an imbalance in the bridge as the heat dissipation in the reference and measuring thermistors.

Some of the methods of design of the humidity sensors and their respective applications are discussed in detail in section 1.3.

1.3 Literature Survey

There are many methods with the help of which an indication of change in the humidity can be achieved. The following section discusses some of the most used methods and the related development in all those methods.

1.3.1 Mechanical

Principle: This type of hygrometer uses the principle in which the change in the humidity can be measured with the expansion and contraction of some materials. The sensing elements that can be useful in this regard are human hair, catgut, cow's intestine, textile plastic, etc.

Operation: A human hair, catgut, cow's intestine, textile plastic, etc. expands with an increase in humidity. This is a basic type of a mechanical humidity sensor. The sensing element (for example, human hair) is connected to the pointer of a dial or a pen of a recording chart through a lever. The expansion and contraction in the length of the sensing element due to an increase or decrease in the humidity can be recorded on the dial of a meter on a recording chart.

These types of sensors are not so reliable in automatic humidity control in industries because of their inability to produce an electrical signal for measurement.

1.3.2 Wet- and dry-bulb psychrometer

Principle: This humidity sensor works on the principle of change in the temperature due to change in the humidity. The temperature difference of two bulbs (wet and dry) of a psychrometer is affected by the surrounding atmosphere's nature; temperature, pressure, humidity, etc. If all the factors governing the change in temperature are kept constant, it is seen that the temperature changes with the variation in humidity [3].

Operation: The configuration of this type of hygrometer is shown in the figure below. It consists of two matched temperature sensors (wet-and-dry bulb, in this case). One sensor is covered with a porous medium at the bottom, for example, a wet sock, shoelace, etc. Its wetness is maintained by a continuous flow of water on it from some kind of reservoir.

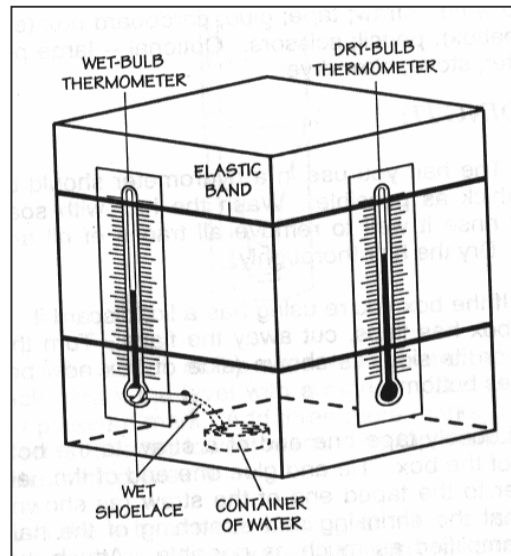

Figure 1.1 Wet and dry-bulb psychrometer

Humid air is blown over these sensors. Due to the presence of humid airflow, water evaporates from the wet sock/shoelace. This evaporation causes the wet sensor to be chilled, which reduces the temperature in the sensor. This is an indication of the humidity in the environment. Readings on both the temperature sensors are recorded and the humidity is calculated with the help of the psychrometric graph, as shown in Figure 1.2.

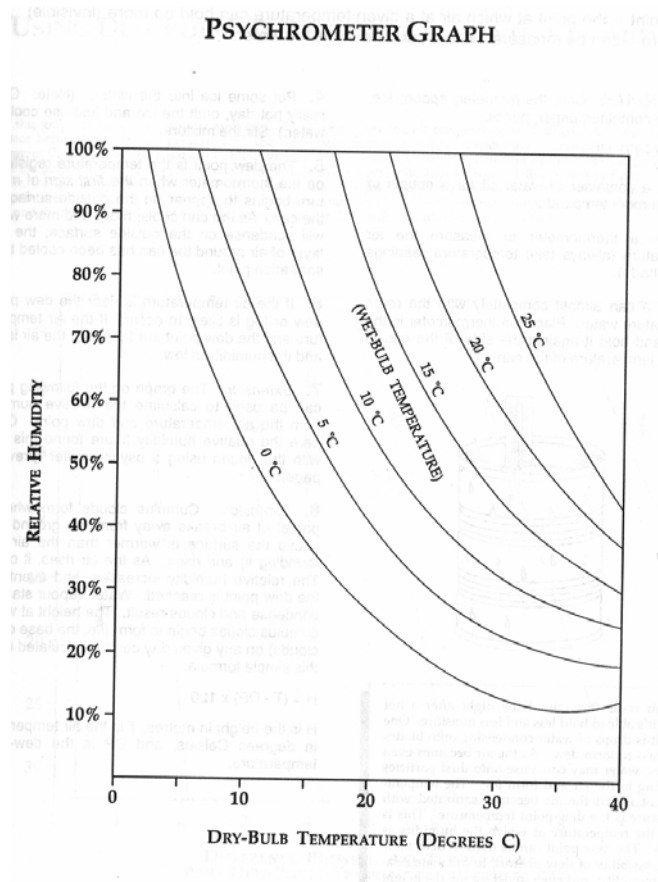

Figure 1.2 Relative humidity and dry-bulb temperature psychrometric graph

For example, if the dry-bulb temperature (the normal temperature of the air) is 20 degrees C, trace a line up from the 20 degrees C marking until the curved line representing the approximate wet-bulb temperature. If the wet-bulb temperature is 5 degrees C, trace a horizontal line to the other axis of the graph, which shows that the relative humidity for this example is about 40% [4].

1.3.3 Resistive Sensors

Resistive sensors work on the principle of conduction. The sensor material used is sensitive to humidity (hygroscopic), and its resistance varies with the change in the amount of water moisture present. From the literature written in the last 20 years, those materials are acetates, fluorides, chlorides, iodides, nitrates, sulphates, carbonates, phosphates, and oxides, as well as polymeric materials. These materials can also be used to design a capacitive humidity sensor [1].

1.3.3a Ceramic Sensors

Ceramic humidity sensors can work for both resistive as well as capacitive humidity sensing. Since capacitive humidity sensors require frequent recalibration and complex circuitry, they are most likely to be used for humidity sensing using the ceramic material. In addition, the range offered by the ceramic capacitive sensors is from 50 to 500pF for a change in humidity from 0% to 50%, with an error of approximately 15%. This range and error are efficient and acceptable in many humidity-sensing requirements.

In order to avoid this, there was a development carried out to design a resistive sensor that has stable and accurate sensitivity characteristics. This sensor was initially developed for use in microwave ovens.

Principle: The humidity sensitive material responds to the humidity, and the response is indicated by the change in the resistance of the material, which is monitored further to extract the humidity information.

Operation: The sensing element is a small porous wafer, which is composed of a ceramic humidity-sensitive material and has a conductive contact metallization on both the sides. The wafer is connected to the control of monitoring circuitry through lead wires. The sensor is installed at the ventilation area of the microwave oven, and it detects the current humidity in the oven as the cooking progresses. Figure 1.3 shows a typical resistive humidity sensor. The typical response of this sensor is such that a change in resistance from 10^2 to $10^4\Omega$ corresponds to a change in the humidity from 10% to 90%.



Figure 1.3 Typical Resistive Humidity Sensor

Though this sensor is linear over the range, the major drawback of this kind of sensor is that it exhibits a precise response only at lower humidity measurements. Also, if

this sensor is exposed to extreme conditions, it tends to saturate and needs intermittent recalibration.

1.3.3b Polyelectrolyte Sensors

Other types of resistive sensors are referred to as “electrolytic” because the sensing material used is polyelectrolyte, which is sensitive to the water content it absorbs. The electrical conductivity of this kind of material depends on the amount of water moisture present and gives an indication of the humidity present in the atmosphere. These types of humidity sensors are also called “humistors” [3].

Principle: When the polyelectrolytic material comes in contact with water, the electrostatically held ions in the material start moving freely, and the resistance decreases accordingly. In other words, the polyelectrolyte electrical resistance variation depends upon the varying conduction of the ions within the hygroscopic polyelectrolyte material.

Operation: The sensor has a polyelectrolytic film deposited over it and connected to the measuring circuitry through metal electrodes. In the presence of humidity, the electrical impedance/resistance of the sensor decreases and a change in the humidity is reported in terms of the voltage. The typical response of the system is such that the resistance of the sensor element decreases by several orders for a change in the relative humidity from 20% to 90%.

Polyelectrolyte sensors are not so popular since the stability is an issue. Also, they are not so useful in dry conditions due to the fact that resistance rapidly increases as dry conditions are met. [2] Moreover, an upward drift in the electrical resistance is observed

with time, which is not so useful in the long run as far as the stability issues are concerned [3].

A study of the variation of the surface electrical resistance shows that lead iodide films can also be used as a good humidity-sensitive material. The surface resistance of a thin film of lead iodide provides better stability and a significantly smaller temperature coefficient of resistance. The resistance of the lead iodide decreases with an increase in the humidity. The typical response of this kind of a sensor shows that the resistance in a logarithmic scale from 8 to 6 corresponds to a humidity change from 45% to 90% relative humidity [3].

1.3.4 Capacitive Sensors

Capacitive sensors are the most popular amongst all the existing humidity sensors. They respond very closely to the change in humidity. In addition to that, they have very little effect of condensation on them (i.e. relative humidity 100%). A typical industrially available capacitive-type humidity sensor is shown in Figure 1.4.



Figure 1.4 Typical Capacitive Humidity Sensor

The capacitive humidity sensor works on the principle of change in the dielectric of the capacitor due to the absorption of water in the atmosphere. The dielectric material

is a hygroscopic material that responds to the humidity after coming in contact with the water content.

1.3.5 Digital Hygrometer

In 1988, a digital hygrometer was developed that worked on the principle of change in capacitance due to a rise or fall in humidity [5]. This hygrometer was made with a polyimide capacitive humidity sensor. The basic idea behind making this kind of a hygrometer was to come up with a linear humidity measurement system.

Principle: In this system, the sensor basically works on the absorption and desorption phenomenon. Due to the polyimide film between the two electrodes, the bulk capacitance between the upper and the lower electrodes changes with the change in humidity after adsorption of the water content by the film. Figure 1.5 shows the Digital Hygrometer.

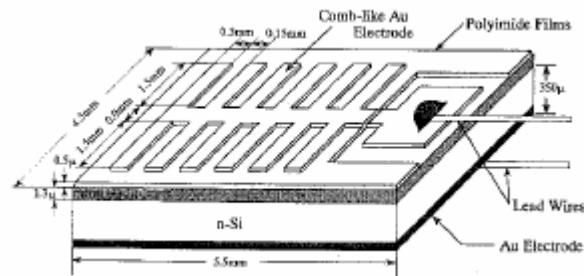

Figure 1.5 Digital Hygrometer [9]

Operation: When the sensor comes in contact with water vapor, due to the absorption of the water on the polyimide film, the capacitance changes, which is an indication of the change and amount of change in humidity. As shown in [5], the capacitance increases rapidly as the humidity in the atmosphere increases. The typical response of the system

shows a change in capacitance from 215pF to 275pF for a change in relative humidity from 20% to 90%.

This hygrometer is very linear and stable and exhibits no hysteresis losses. Polyimide performs extremely well in a high-temperature environment ($>400^{\circ}\text{C}$) [6] and has a high resistance to other chemicals that can affect the measurement.

The disadvantage of this system is that the response time is quite high in long-run operations, and the capacitance changes slightly with a change in the measurement frequency.

1.3.6 Polymer Dielectric Sensors [2]

In recent years, many capacitive humidity sensors have been developed using a polymer dielectric material. Even though their response is temperature sensitive, they exhibit a good relation between the capacitance and moisture.

Principle: It is based on the change in the dielectric constant of a porous polymer film due to a change in humidity. The dielectric constant changes after it absorbs the water content from the environment.

Operation: The polymer sensor is made up of two electrodes separated by a polymer film, which is a humidity-sensitive material. The polymer has a dielectric constant of ≈ 5 , and that of water is ≈ 80 . The water absorption by the porous polymer film leads to a change in the dielectric constant of the polymer and, in turn, the capacitance of the sensor.

Polymeric humidity sensors are commercially successful because of their bulk phenomenon (rather than the surface phenomenon) and their low cost of production. It is observed that these sensors exhibit slow response, and the temperature compensation is required in order to avoid the change in the capacitance due to temperature.

Amongst all humidity sensors commercially available, capacitive sensors are the most preferred. In spite of so much development in these kinds of sensors, they offer disadvantages like slow response and less accuracy. [2]

1.3.7 A High-Speed Capacitive Humidity Sensor [6]

In order to overcome these disadvantages, a high speed, more accurate humidity sensor was developed in April 2000. The speed of a capacitive humidity sensor can be changed by using a more humidity-sensitive material or by a change in the shape/geometry of the sensor film. In this project, the geometry of the sensor was changed. As shown below, the conventional parallel plate-structured sensors have only one side of the sensing layer exposed to the moisture.

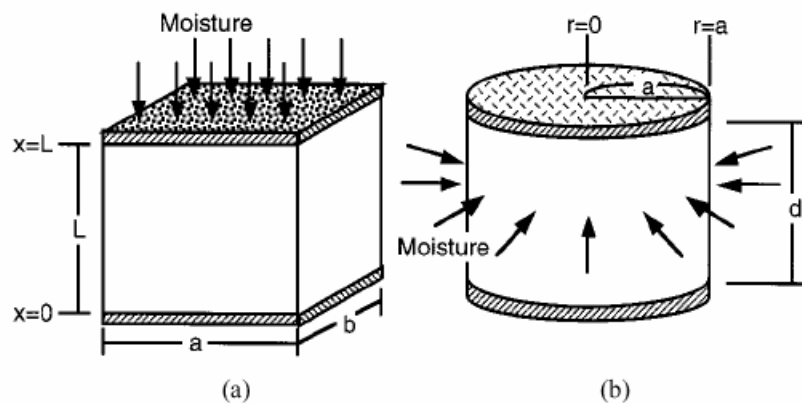

Figure 1.6 High-speed capacitive humidity sensor

The newly-developed cylindrical sensor has polyimide columns of a very small diameter available, which allows maximum absorption of the humidity. Polyimide is used as the hygroscopic material, and it is deposited on a polysilicon material, which acts as a heater. The heater prevents condensation, which is the important factor in the recovery period of the sensor. The sensor exhibits high speed because of the application of the moisture around the circumference of the sensor film.

The sensor shows a response time of 1.0 second for a polyimide diameter of 5 μ m. Further speed enhancement can be achieved by using polyimide film columns with lesser diameters. Some other methods that are currently employed as per the application area are discussed further in brief.

1.3.8 Spectroscopic

Water has a tendency to absorb infrared radiation at wavelengths ranging from 1 μ m to 10 μ m. The intensity of the transmitted infrared radiation is measured at the receiving end, and the presence of water is detected. This is more like a non-contact type method, which is useful in an application area where contact with the humidity sensor is to be avoided. The amount of radiation absorbed indicates the concentration of water vapor present. Spectroscopic methods are useful when very low water content is to be detected.

1.3.9 Color Change

These types of humidity sensors indicate a change in the color of a paper strip or any other material as a result of humidity variation. The sensing material used in this case is cobalt chloride, which changes its color in the presence of humidity. This method is more like an indication than a measurement.

1.3.10 Acoustic

The change in the transmission of sound in air or any other material can indicate the humidity variations.

1.3.11 Piezoelectric

The change in the resonating frequency of a quartz crystal indicates the mass of water absorbed from the air.

1.3.12 Thermal conductivity

Water vapor, as well as other gases, and the respective humidity affect the heat loss from a hot wire. In this type of a humidity sensor, a thin platinum film is used as the hygroscopic material. Using the temperature-resistance characteristics of this film and the detection of thermal conductivity in water and air, the amount of moisture present is indicated [7].

1.4 Need of Fiber Optic Humidity Sensors

1.4.1 Fiber Optic Sensor Technology: Introduction and Background

Fiber optic sensor technology started its development in the 1960s when LASER and a low-loss optical fiber was introduced. After that, there has been a lot of research in this particular area due to its several advantages over conventional sensors [8]. Some of the advantages are mentioned below:

1. Precision and sensitivity: Due to the absence of any electrical quantity in the transmission of the data through the optical fiber, the fiber optic sensor is immune to the electromagnetic disturbances and electrical hazards that affect the measurement accuracy and precision the most in conventional electrical sensors.
2. Remote Sensing: The optical fiber transmission cables offer significantly lower signal loss compared to other conventional sensors. The high signal-to-noise ratio offered by the fiber optic cable enables it to be used in a remote sensing application where there is a need to measure a physical parameter from a remote place away from the actual plant.
3. Distributed measurement: The optical fiber communication network allows the user to carry out measurements at different points along the transmission line without much loss in the signal passing through it. This provides an extended means to monitor, control and analyze the process.
4. Transportation Ease: Since the optical fiber cables are very lightweight, transportation to any remote plant is easy, which is not true with conventional measurement and transmission networks.

5. Operation under hazardous conditions: Fiber optic sensors have proved to be very accurate and stable under extreme conditions such as very high temperature, electromagnetically-influenced surroundings and other harsh environments.
6. Compactness and versatility: Optical fibers are basically much more compact in nature, which helps to build a compact measurement and acquisition system. Furthermore due to its ability to perform well in any kind of measurements, it is proven to be very versatile.

Fiber optic sensors are mainly categorized into three categories: intensity sensors, polarimetric sensors and interferometric sensors [9]. Intensity sensors measure the change in the intensity of the light carried by an optical fiber and the loss/increase in the intensity of light due to the presence of the parameter being sensed. The polarimetric and Interferometric sensors sense the change in the polarization state of the light passing through the optical fiber.

Fiber optic sensors can also be classified on the basis of their applications: physical sensors, which measure temperature, stress, etc.; chemical sensors which measure pH content, gas analysis, spectroscopic studies, etc. and, bio-medical sensors, optical fibers inserted via catheters or endoscopes, which measure blood flow, glucose content and so on. Both the intensity types and the interferometric types of sensors can be considered in any of the above applications [10].

Extrinsic or intrinsic sensors are another way of classifying fiber optic sensors. In the former, sensing takes place in a region outside of the fiber, and the fiber essentially

serves as a conduit for the bi-directional transmission of light to the sensing region efficiently and in a desired form. In an intrinsic sensor, one or more of the physical properties of the fiber undergo a change [10].

The following section discusses the various approaches being carried out in the field of humidity sensing using fiber optic sensors. As there is no electrical signal involved in the measurement, the optical fiber humidity sensor can work in harsh industrial environments. Due to this, the fiber optic sensor technology is maturing rapidly to catch up with commercially available humidity sensors with respect to precision and response time. In addition, a fiber optic humidity sensor that can be used to measure humidity at several places at one time (distributed measurement) can be of immense importance in civil structure monitoring.

There have been various approaches carried out by the Diagnostic Instrumentation & Analysis Laboratory (DIAL) at Mississippi State University for the use of optical fibers in the design of sensors employed in measurement of physical parameters like strain and humidity. In this project, we have tried to come up with two types of humidity sensors,

- Fiber optic humidity sensors based on a mechanical phenomenon
- Fiber optic humidity sensor based on a chemical phenomenon.

1.4.2 Fiber optic humidity sensor based on a mechanical phenomenon

This sensor is primarily based on the “micro-bending” principle of an optical fiber. Small bends in an optical fiber produce loss at the other end, which can be detected and

used as an indication of the change in the physical parameters. In other words, if a physical parameter to be measured changes the bending in the fiber, the change can be monitored at the detector end.

1.4.3 Fiber Optic Humidity Sensor based on a Chemical phenomenon

This humidity sensor uses a hygroscopic chemical that is deposited on the optical fiber. The property of the chemical to change its behavior in presence of water leads to a loss/increase in the light passing through the optical fiber, which in turn changes the output at the detector.

In addition to the basic design of the sensor, we have tried to come up with an online PC-based data acquisition system with a program written in LabVIEW. This program is used to measure the humidity from the standard humidity probe, as well as from the designed humidity sensor, and to compare and calibrate the designed sensor with the standard humidity probe.

These methods, their operating principle, theory, design, implementation and results will be discussed in subsequent chapters.

CHAPTER II
CURRENT APPROACH: HYDRO-GEL DEPOSITED FIBER OPTIC
HUMIDITY SENSOR

2.1 Principle

This approach is based on the “micro-bending of an optical fiber” phenomenon, as shown in Figure 2.1. Losses in optical fibers because of periodic, axial micro deformations have proven to be an indication of change in a physical parameter [11].

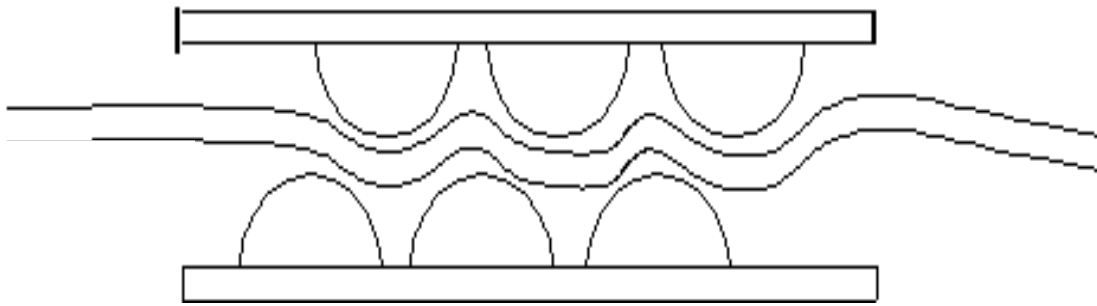

Figure 2.1 Microbending in an Optical Fiber

As can be seen in Figure 2.1, the micro-bending in the optical fiber leads to a loss in the light passing through the optical fiber, which consequently changes the output at the light detector. One of the major advantages of this type of humidity sensor is that they are very simple and robust in construction, which enables them to be used in harsh

environments in industries. The chemical that was used as the hygroscopic material in the development of a fiber optic based sensor at DIAL at Mississippi State University was “hydro-gel”, which produces micro-bending in the optical fiber due to its behavior in the presence of moisture. This section describes a distributed optical fiber humidity sensor, which has the ability of detecting the moisture content and can be very useful in civil engineering for soil moisture measurements.

2.2 Background

The approach of fiber optic humidity measurements using hydro-gel deposition and the micro-bending phenomenon carried out at DIAL, Mississippi State University, was based on an approach carried out at the Optoelectronic Division, Department of Pure and Applied Chemistry, UK [12]. The mechanical interaction between the hygroscopic polymer hydro-gel and the optical fiber due to micro-bending was presented in the paper. The sensor developed in this fashion exhibits a relative humidity measurement capability ranging from 70% to 100%. This approach was implemented by producing micro-bendings in the optical fiber by placing the fiber on a hydro-gel coated Glass Reinforced Plastic (GRP) carrier rod. The fiber was then held against the rod with the help of a helically wound Kevlar thread. A 250-micron radius optical fiber was used with a 15-20 microns thick hydro-gel coat. In the presence of water, as the hydro-gel swells, it exerts pressure on the fiber to produce micro-bendings and, in turn, losses at the other end of the fiber [12].

Various approaches were carried out in this regard in order to study the mechanical interaction of the optical fiber in the presence of hydro-gel. A set of plates with similar periodic grooves was produced in order to produce more bendings and in turn more loss in the optical fiber. The grooves were made at a distance of 2mm. A micropositioner was mounted on the top of one of the plates in further experiments in order to monitor the attenuation in the signal passing through the fiber with the mechanical movement of the fiber as the polymer swells. The research was done on the mechanical interaction of the optical fiber in response to humidity in the presence of water. The experimental analysis showed that distributed sensing can be achieved by implementing any of these approaches for humidity measurements in a hazardous environment, and this sensor has the ability to sense very low levels of moisture in sands and clays.

2.3 Theory and Experimental Set-up

Hydro-gels are polymeric materials that have the property of swelling in the presence of water. This swelling behavior produces an increase in the physical dimensions (volume) of the material, which can be converted to a mechanical response. The extent to which the material can swell depends upon the amount of water absorbed [12]. Thus the micro-bending phenomenon can be easily implemented to detect the presence of humidity in the surrounding environment using hydro-gel. One of the initial challenges was to come up with a good composition of hydro-gel in order to carry out the experiment, as none of the previous references specified the exact composition of hydro-

gel. Initial preparations of hydro-gels were successful in absorbing considerable amounts of moisture but did not release it. A good composition of hydro-gel (reversible and sensitive) was finally obtained after several trials. One of the best hygroscopic gels produced was T-PEG990/DesW, where T-PEG990 is a branched tri-functional polyethylene glycol and Des W refers to Desmodur W, a source of hydrogenated methylene-phenylene-isocyanate[19]. The hydrogel composition is T -PEG 990 (11.88 g) + PPO / PEG(0.85 g) + Desmodur W(5.0 g)

2.4 Sensor Construction

Figure 2.2 shows the basic design of the optical fiber humidity sensor with the hydro-gel and micro-bending principle as designed in the approach carried out at the DIAL, Mississippi State University.

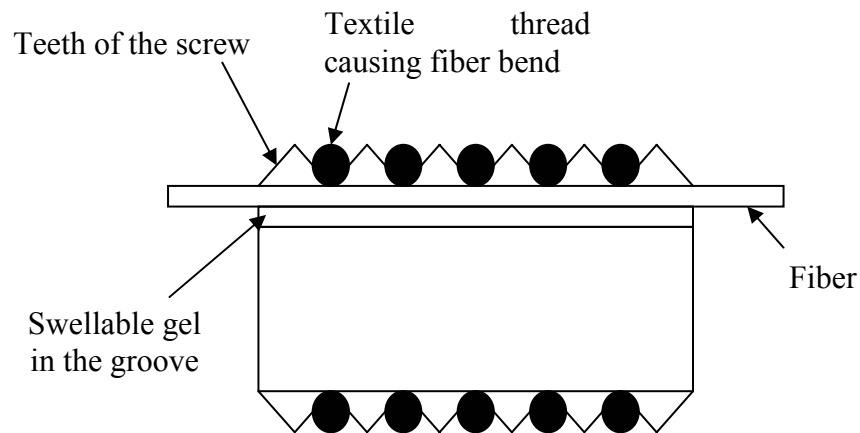

Figure 2.2 Design of the Sensor

As can be seen from the figure, an optical fiber was mounted on a metal screw, grooved at a pitch of 1mm. A through channel was made on top of the groove and was filled with the hydro-gel prepared. The fiber was then placed in the channel and was held tightly on the screw with the help of a simple textile thread. The threads also helped in producing micro-bends in the fiber against the screw when the hydro-gel swelled in the presence of moisture. For the initial experiments, the thread was tied on the screw at a distance of 2mm in order to analyze the sensor response. In further experiments, the thread was tied at a distance of 1mm. In other words, the micro-bends were produced at a distance of 1mm. The light (laser emitted by a laser diode) passing through the optical fiber was detected by the photodiode/phototube at the detector end.

2.5 PC-based Online Data Acquisition System

The data-acquisition system employed for monitoring the sensor data online was comprised of a data-acquisition board (Manufactured by: Computerboards), an I/O connector to connect the optical fiber output from the detector to the PC via the board, a BNC cable, wires, etc. The program that acquires the data from the process was written in LabVIEW, version 4.0 (Refer to Appendix A). This program can read the voltage from the photo-detector and plot the data onto a chart in real time. The program also saves the data in a file (with an option of the kind of representation desired by the user) for further analysis of the sensor. The data acquisition system also had an oscilloscope in order to compare the reading at the actual process location with the readings on the PC at a different location. The program also features different time settings of acquisition and

reports the data in the file with respect to the time intervals entered by the user. The program produces a user-friendly graphical representation of the data acquired and has the ability to acquire and display 8 differential or 16 single ended outputs on different charts.

2.6 Sensor Operation and Experimental Procedure

In order to analyze the behavior of the sensor thus prepared, the two ends of the optical fiber cable were polished with the help of polishing papers. The fiber was tied with a thread on the gel-coated screw and was coupled with the laser diode on one end and the detector on the other end. The detector was connected to an oscilloscope as well as the PC-based data acquisition system through an I/O connector. The LabVIEW program was run to analyze the sensor response and get a graphical representation of the effect of moisture on the sensor in real time. Moisture was introduced by putting wet paper towels on the swellable gel (hydro-gel) coated screw that held the optical fiber. Due to the presence of moisture, the gel swelled, and additional bends were produced in the fiber. According to the property of the optical fibers, these bends led to a loss of the signal passing through the fiber at the output end. The loss in the output is an indication of the moisture present in the surrounding atmosphere. In order to analyze the sensor behavior, the moisture introduced was taken off, and the output of the sensor was monitored. The following section discusses the results obtained with the hydro-gel based fiber optic humidity sensor.

2.7 Results and Discussion

The first experiment performed on the sensor was done without the data acquisition program. The readings were taken manually in an intermittent fashion after a period of time by measuring the voltage at the detector with the help of a digital voltmeter. Some of the results achieved are shown in Table 2.1 and Figure 2.3, respectively.

Table 2.1

Hydro-gel Based fiber optic humidity Sensor Response (manual readings)

TIME	VOLTAGE OUTPUT ON OSCILLOSCOPE (MEAN)(mVolts)
8.25am	440 (Moisture introduced)
9.25am	460
10.35am	340
1.40pm	300 (Moisture removed)
4.05pm	440

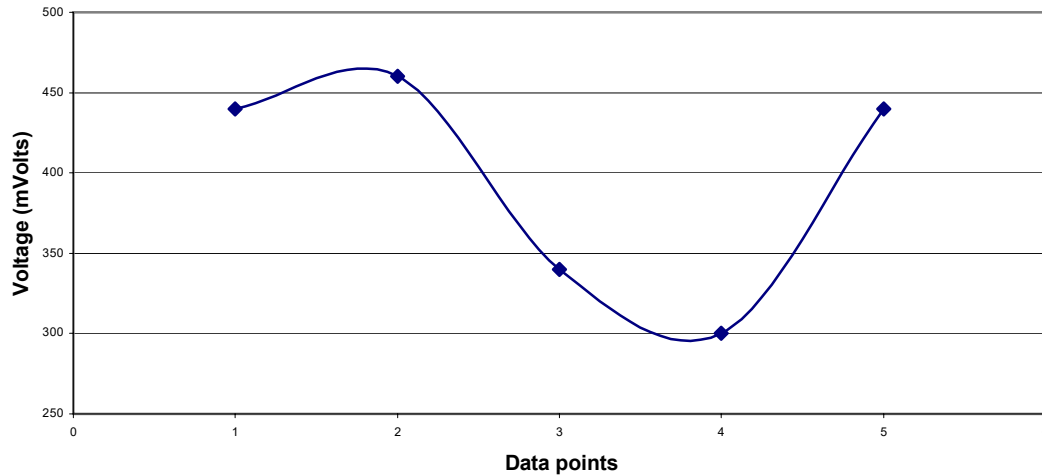

Figure 2.3 Hydro-gel Based fiber optic humidity Sensor Response (manual readings) (A)

The result above shows the sensor response for moisture introduced at the reading on the photo-detector equal to 440mVolts. As the moisture increases, the fiber is pushed against the thread due to the swelling property of hydro-gel. This causes microbendings at places where the thread is holding the fiber against the steel rod. This in turn causes loss in the light intensity passing through the optical fiber, which is detected at the photo detector. As can be seen from the plot, the voltage decreases with the increase in the moisture, till the moisture is removed at 340mVolts, and then increases to restore the original value.

In the next experiment (Table 2.2, Figure 2.4), the power (mW) from the optical detector was measured as an indication of the change in the moisture.

Table 2.2

Hydro-gel Based fiber optic humidity Sensor Response (manual readings, power output)

TIME	POWER OUTPUT (MEAN)(mW)	POWER OUTPUT (ACTUAL)(mW)
9.50am	11.06	11.4-11.8 (Moisture introduced)
11.21am	11.12	11.12
12.20pm	10.48	10.48
1.30	10.34	10.28-10.40
2.30	9.43	9.43
3.25	10.42	10.42 (Moisture Removed)
4.15	10.75	10.7-10.8
4.25pm	11.03	11.03

Hydrogel Based Fiber Optic Humidity Sensor Response (Manual Readings)

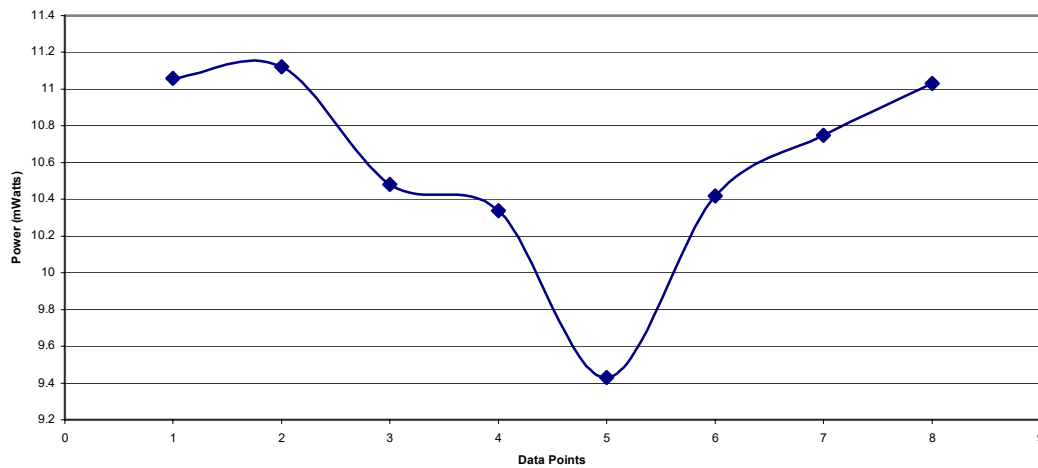

Figure 2.4 Hydro-gel Based fiber optic humidity Sensor Response (manual readings, power output)

Table 2.3

Hydro-gel Based fiber optic humidity Sensor Response (manual readings) (B)

TIME	VOLTAGE OUTPUT ON OSCILLOSCOPE (MEAN)(mVolts)	VOLTAGE OUTPUT ON OSCILLOSCOPE (ACTUAL)(mVolts)
9.40am	440	440(Moisture Introduced)
9.45	480	480
10.00	480	480
10.50	450	440-460
11.50	420	420
1.25pm	260	260
2.10	320	320
2.15	360	360
3.00	380	360-400 (Moisture Removed)
4.00pm	420	420

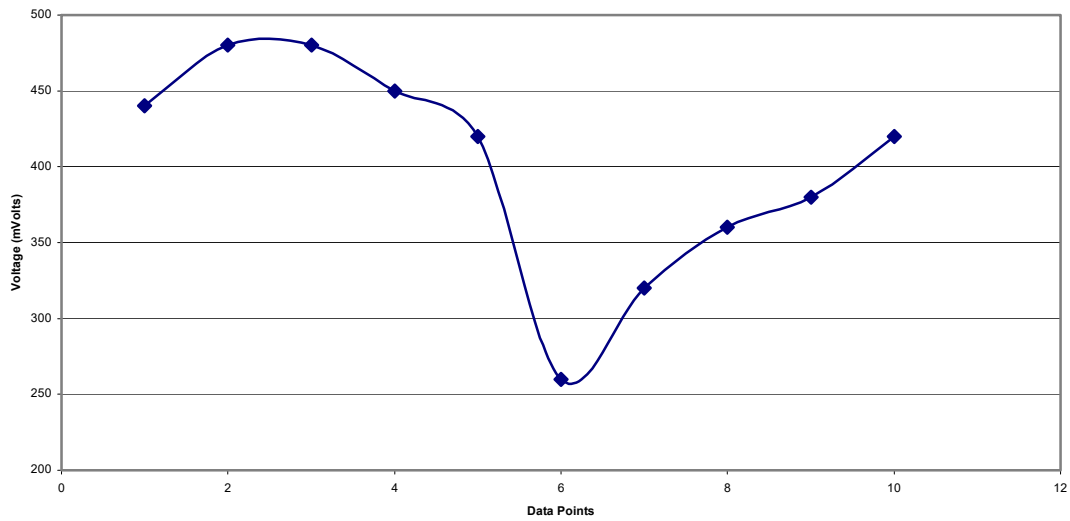

Figure 2.5 Hydro-gel Based Fiber Optic humidity Sensor Response (Manual Readings) (B)

As can be seen from the manual readings (Table 2.3, Figure 2.5), the basic disadvantage is the intermediate behavior of the sensor between two readings. In order to resolve this problem and for exact analysis of the sensor, a PC-based data acquisition system was developed with the help of a program written in LabVIEW. The program uses the data acquisition board manufactured by Computer-boards and an I/O connector to get the data from the detector to the PC [Refer to Appendix A]. The program provides a complete graphical representation of the parameters measured and also provides the following features:

- Choice of time (in seconds) to wait between display of the data acquired on the graphical user interface,
- Printout of the traces acquired, immediately after the acquisition is completed,

- Data storage in a file with the type of extension and location desired by the user by prompting the user before the program actually starts,
- Web-based documentation that provides access to the results (graphical representation as seen on the screen) on the internet at any time when the program is running.

Figure 2.6 shows typical results obtained by the data acquisition system for the Hydro-gel fiber optic humidity sensor.

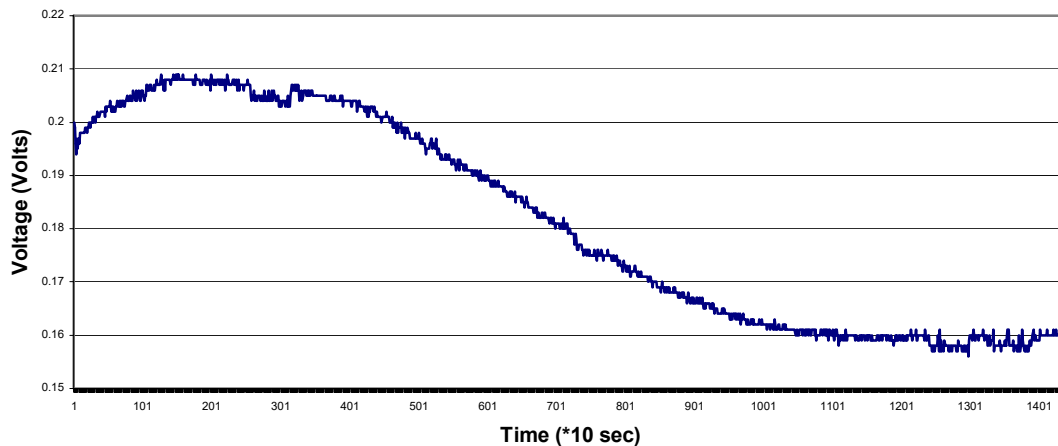

Figure 2.6 Hydro-gel based fiber optic Humidity Sensor Response (with moisture introduced, bends at 2mm)

Figure 2.7 shows the response of the sensor as obtained after employing the data acquisition system and the program written in LabVIEW. As can be seen from the plot, the characteristics of the sensor are exposed in detail and it is easy to analyze the behavior of the sensor.

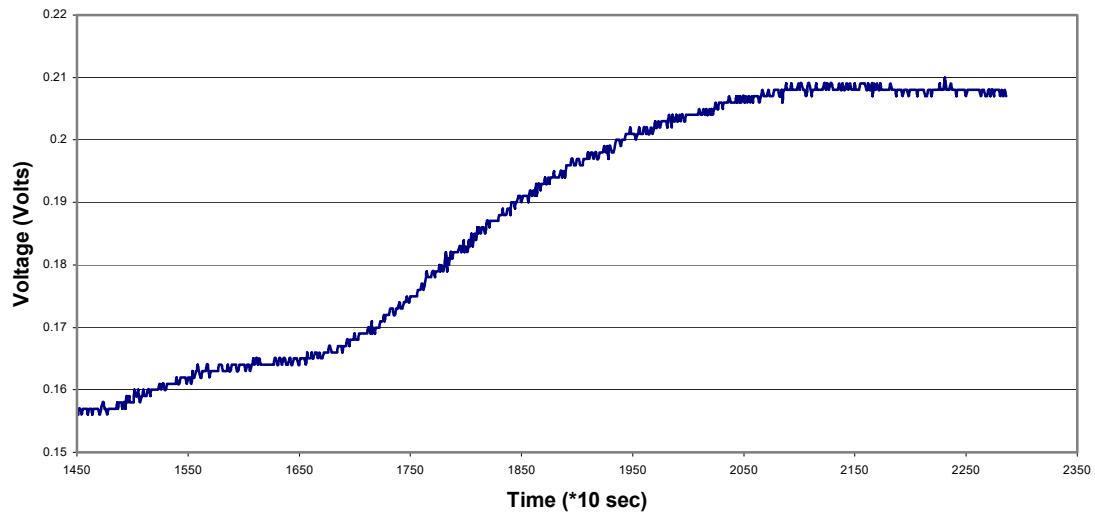

Figure 2.7 Hydro-gel based fiber optic Humidity Sensor Response (with moisture removed, bends at 2mm)

The complete behavior of the sensor is as shown in Figure 2.7

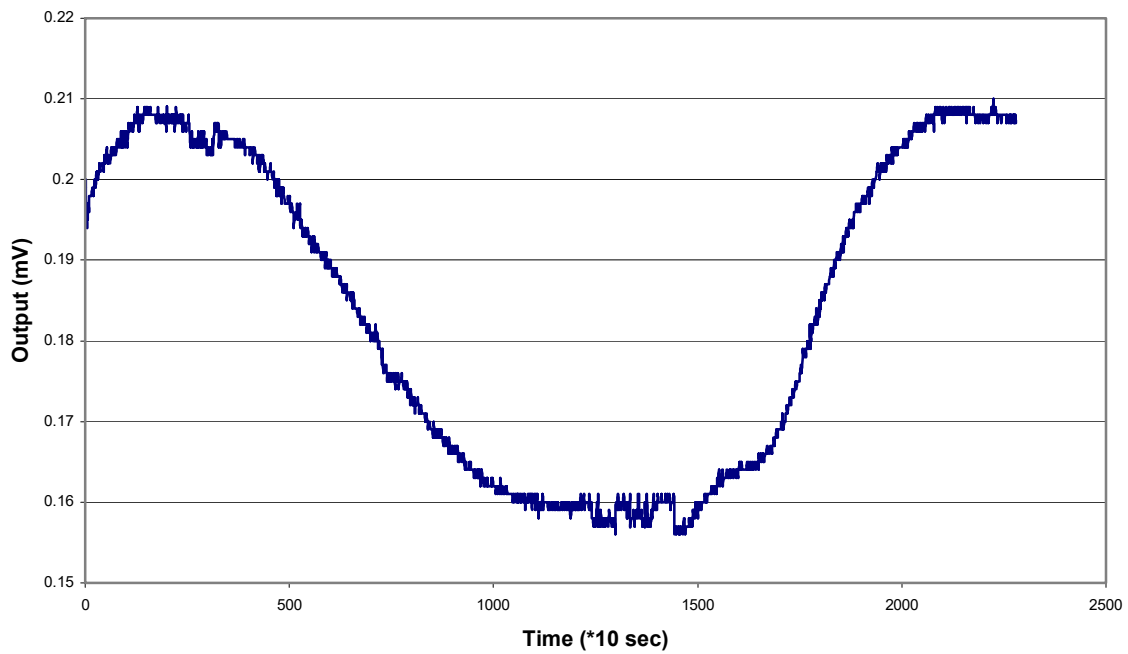

Figure 2.8 Hydro-gel deposited Fiber Optic Moisture Sensor Characteristics (bends at 2mm)

One different approach was employed in order to analyze the sensor behavior for different conditions. The bends in the fiber were originally produced at a distance of 2mm by winding the textile thread around it at that distance. Winding the thread at a distance of 1mm reduces the distance at which the bending takes place. This was done in order to come up with more loss in the fiber and greater dynamic range of the detector for the same change in the humidity/moisture.

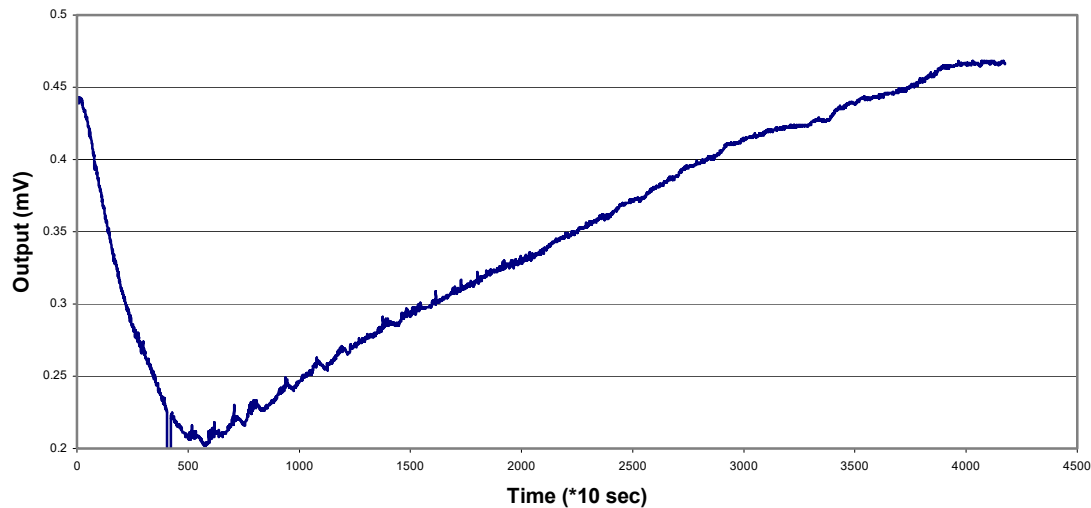

Figure 2.9 Hydro-gel deposited Fiber Optic Moisture Sensor Characteristics (bends at 1mm)

2.8 Conclusion and Summary

A hydro-gel-based fiber optic humidity sensor was built, tested and monitored for the relative humidity measurement. The sensor provides good response to the change in relative humidity for a considerable dynamic range (in volts), which can be compared with a standard humidity probe for the calibration purpose of the sensor. Also, because of its simple construction used to achieve micro-bending and in turn loss in the optical fiber, it can be easily employed.

From the results of the Hydro-gel Deposited Fiber optic humidity Sensor Response, it was revealed that the main disadvantage of this sensor is that its response time is too high. The normal time of the whole procedure, starting right from the introduction of the moisture till the moisture is removed, is roughly around 7 to 8 hours.

The response of the sensor ranges from 3 to 4 hours from the time the moisture is

introduced or removed. In addition to this, the hydro-gel becomes hard after multiple experiments with the same gel. This reduces the property of the gel of absorbing and swelling in the presence of water, which makes the sensor less repeatable. This produced a need to come up with a faster and more repeatable humidity sensor that can yield results within a very short period of time, which can be more helpful in real-time moisture measurements.

CHAPTER III

A CHEMICALLY DEPOSITED OPTICAL FIBER HUMIDITY SENSOR

3.1 Introduction

This chapter deals with the background, selection, and design of a chemical deposited fiber optic humidity sensor. Various experiments had been carried out in the last couple of decades in order to come up with a fast-responding fiber optic humidity sensor based on the chemical deposition phenomena. Cobalt Chloride (CoCl_2) has proved to be a good indicator of moisture when deposited on an optical fiber [13].

3.2 Working Principle

In this section, various approaches and their working principles are discussed. All of these approaches work on the intensity-based sensor phenomena in which the absorption of the light propagating through the optical fiber is absorbed as the humidity increases. In order to implement this, there has to be an interaction between the light propagating through the optical fiber and the moisture present in the atmosphere.

One of the approaches is based on the absorption of the “evanescent tail” of the light passing through the optical fiber. The evanescent tail, as shown in Figure 3.1, is the falling edge of the light intensity curve propagating through the optical fiber.

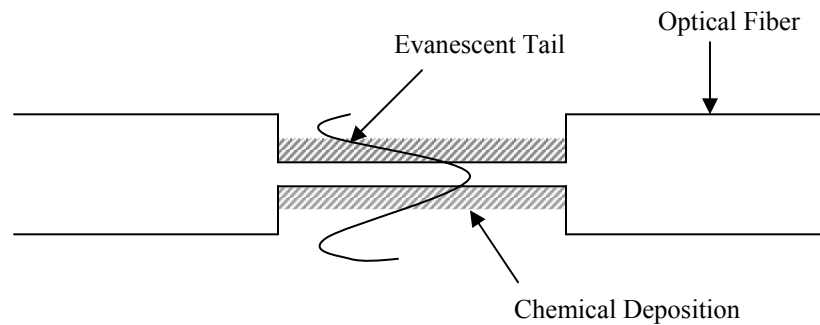

Figure 3.1 Evanescent Tail Absorption

Figure 3.1 shows a cladding removed, chemical deposited optical fiber, which works on the evanescent tail absorption principle according to the moisture present in the atmosphere. This approach provides a smaller dynamic range as just the tail of the light passing through the optical fiber core is absorbed.

In order to achieve maximum light absorption, another approach can be carried out, in which the optical fiber is bent in order to interact with the peak of the light propagating through the fiber and obtain maximum absorption. Bending of the probe tends to get more light out of the optical fiber and thus achieves more interaction of the light with the chemical deposited on the fiber, causing more loss in the optical fiber as a reaction to an increase in the humidity [14].

A similar approach is one in which a porous optical fiber is made in order to achieve more interaction with increased sensitivity for humidity measurements [15]. Since this requires a manufacturing facility, it is difficult to implement.

Fiber optic devices consisting of a polished fiber and overlay material show attenuation in the signal passing through the optical fiber. Cobalt Chloride (CoCl_2) used as the sensitive material changes its refractive index depending on the moisture content in

the environment. This change in the refractive index induces variations in the transmitted power along the fiber polished with CoCl_2 [16]. Typical transmission spectra measured on a Cobalt Chloride (CoCl_2)-treated optical fiber saturated by moisture (A) and dried by air (B) is shown in Figure 3.2.

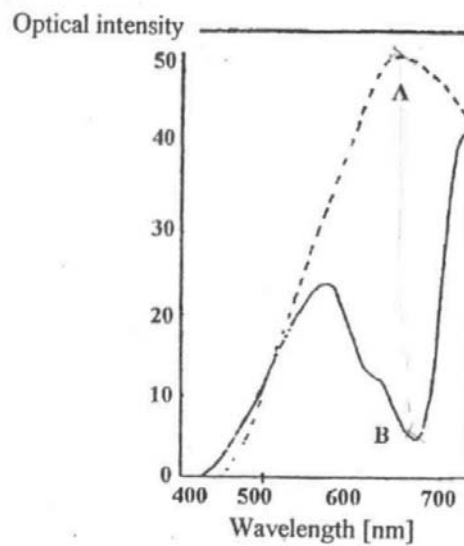

Figure 3.2 Transmission Spectra Measured on a Cobalt Chloride (CoCl_2)-treated Optical Fiber Saturated by Moisture (A) and Dried by Air (B) [17]

There have been various approaches carried out with the CoCl_2 aqueous solution and a porous material like gelatin or PVA (Polyvinyl Acetate), which holds the CoCl_2 on the fiber. This sensor works on the principle of an increase or decrease of the signal in the CoCl_2 deposited fiber due to a change in moisture in the atmosphere. The following section discusses the developments carried out and results obtained with all the above mentioned approaches till now.

3.3 Background and Results

The interaction of CoCl_2 with water vapor was the basic idea behind the research carried out in the fiber optic humidity sensor designs. A film of CoCl_2 and gelatin was used by Russell and Fletcher on a $600\mu\text{m}$ optical fiber [18]. This experiment discusses the deposition of this film on the optical fiber and control over the humidity to monitor the change in the output of the fiber as a result of the presence of moisture in the atmosphere. The design of the sensor included stripping off the cladding of a plastic-clad silica fiber as the first step. Then, a porous film of CoCl_2 and gelatin aqueous solution (4% gelatin and 2% CoCl_2) was deposited on the cladding-removed area by dipping the fiber in the solution. The fiber was then dried at room temperature. The results mentioned in the paper show that the sensor responds for a relative humidity range from 40% to 80% RH. Corere, Gaston and Sevilla, using gelatin as the overlay material and CoCl_2 as the hygroscopic material, carried out one more approach in the same regard. Their results show that there is a 30dB change in the power at the output of the optical fiber for a change in the humidity from 75% to 100% [16].

Another similar approach was carried out by depositing Rhodamine B/hydroxypropyl cellulose humidity-sensing film on a part of the fiber (sensing area) [14]. This was also done after removing the cladding from the fiber. The new approach introduced in this experiment was to use a curved fiber in order to achieve maximum interaction of the light with the humidity-sensitive material. The experiments performed showed that this enhanced the sensor results, and the relative humidity measurement that was achieved with this sensor ranged from 0% to 95% RH. The reason behind this

increase in range was that the bending of the optical fiber causes more light to exit the fiber in the bent portion. Thus, there is more light interacting with the chemical deposition. Another advantage of this sensor was that the response time was considerably smaller.

In each of the above-mentioned approaches carried out in the last few years, it has been seen that CoCl_2 is arguably the best hygroscopic material that can be used effectively to measure humidity with optical fiber sensors. CoCl_2 can be used with overlay materials such as gelatin and PVA (Polyvinyl Acetate). The overlay material should be such that the aqueous solution prepared for polishing the fiber with CoCl_2 should be able to absorb and desorb water. The experiments, undertaken by Corera, Gaston and Sevilla, showed that the results obtained from the CoCl_2 overlaid with gelatin did not yield useful results, and the optical fiber device was not able to detect the presence of water. The reason behind this, as mentioned in the paper, was that the texture of the gelatin was not homogeneous, resulting in poor adhesion to the fiber. However, the experiments carried out with CoCl_2 overlaid with PVA showed good results in the presence of moisture [16]. This result and the literature survey of current approaches being carried out with the chemical deposition on the optical fiber to come up with a humidity sensor helped in the design of a sensor. It was decided to opt for a PVA and CoCl_2 polished optical fiber to design a chemically deposited fiber optic humidity sensor for humidity measurements. The remaining sections in this chapter discuss the construction details for the design of the sensor and related experimental set-up for observing the working of the sensor.

3.4 Experimental Set-up

3.4.1 Sensor Construction

The procedure for the construction of this sensor consisted of polishing the optical fiber ends (refer to Appendix B), and then removing the jacket of the fiber from the central position with the help of a simple, single-edge razor blade. Once the jacket was removed, the cladding of the fiber was removed. There are various procedures that can be employed in order to achieve this. In the preliminary experiments, the cladding was removed by dipping the jacket-removed area of the optical fiber in acetone, which was recommended by the manufacturers of the optical fiber. After removing the cladding carefully, the fiber was coated with a thin film of PVA and CoCl_2 by dipping the fiber in the aqueous solution of PVA and CoCl_2 . The composition of the aqueous solution used for coating the cladding-removed area of the optical fiber was 2% PVA and 1% CoCl_2 [16]. The fiber was then coupled with the laser source and the detector through a climate chamber, which was designed in order to have control over the humidity. The optical fiber was fixed in the chamber such that the humidity-sensitive area of the sensor remained in the chamber. The construction of the climate chamber is discussed in the next section.

3.4.2 Climate Chamber

In order to have control over the humidity of the air that was to be blown on the humidity sensor (optical fiber), a glass climate chamber was built. This climate chamber had an inlet and outlet to let the optical fiber through it. It also had an opening at the top

to insert a standard humidity probe, which was useful in order to compare the results of the optical fiber humidity sensor and the standard commercially available humidity probe (*Manufacturer: Pace-Scientific*) and for calibration purposes. The climate chamber also had a vent for the humid as well as dry air to be introduced in it on the side wall of the chamber. A valve that controlled the flow of dry air and humid air in such a way that either the humid or the dry air could enter the chamber was mounted on the top of the chamber. The entire experimental set-up is shown in Figure 3.3.

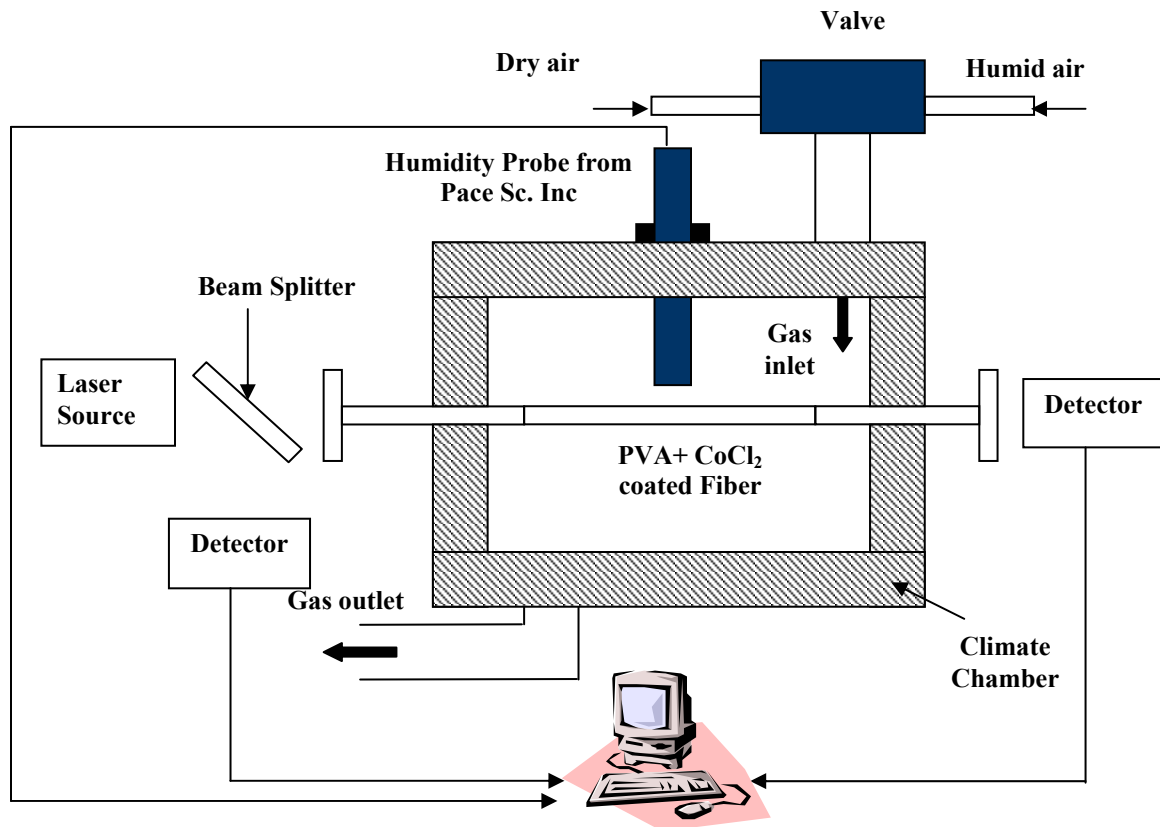

Figure 3.3 Experimental set-up

The optical fiber was held tightly with the help of grease at the two slots in the chamber on the side walls in order to assure that the fiber did not move, due to the air

blown in the chamber, as the experiment proceeded. The output from the standard humidity probe was connected to the data acquisition card (Manufacturer: Computer-boards) through the I/O connector. The output of the optical detector was also connected to the card. The data read from the standard humidity probe was acquired in voltage, which was then scaled from voltage to relative humidity in the program written in LabVIEW, producing a plot showing the actual relative humidity present in the chamber. Furthermore, the voltage from the standard humidity probe was also monitored and displayed on the front panel of the program in order to compare the two voltage readings, one from the fiber optic humidity probe under experimentation and the other from the standard humidity probe. The program also included the ratio of the actual optical fiber output and the laser output, in order to compensate for any variations in the laser output. The laser output was also monitored in order to keep track of the variations in the laser output and its effect on the humidity monitoring.

3.5 Experimental Procedure –Results and Discussion

While conducting the actual experiment, the moisture was introduced to the chamber by the nebulizer, and the plots of the standard humidity probe and the fiber optic humidity sensor were observed. In order to remove the moisture, dry air was introduced in the chamber from a dry air cylinder through the valve at the top of the chamber. Some of the results are shown in this section, followed by the related discussion and conclusions. In order to study the effect of the dimensions of the optical fiber on the response of the sensor, a 200 μm as well as a 300 μm optical fiber were used. The results

show the performance of the sensor in response to the coating on the cladding removed optical fiber.

Figure 3.4 shows a comparison of the standard humidity probe and the fiber optic humidity sensor with a coat of 2% PVA and 1% CoCl_2 . It can be seen that the dynamic range of the designed sensor ranges from 1.3 volts to 1.9 volts (approximately) for a change in the relative humidity of 20% to 90%. It can also be noted that the designed sensor is much faster than the standard capacitance-based humidity probe.

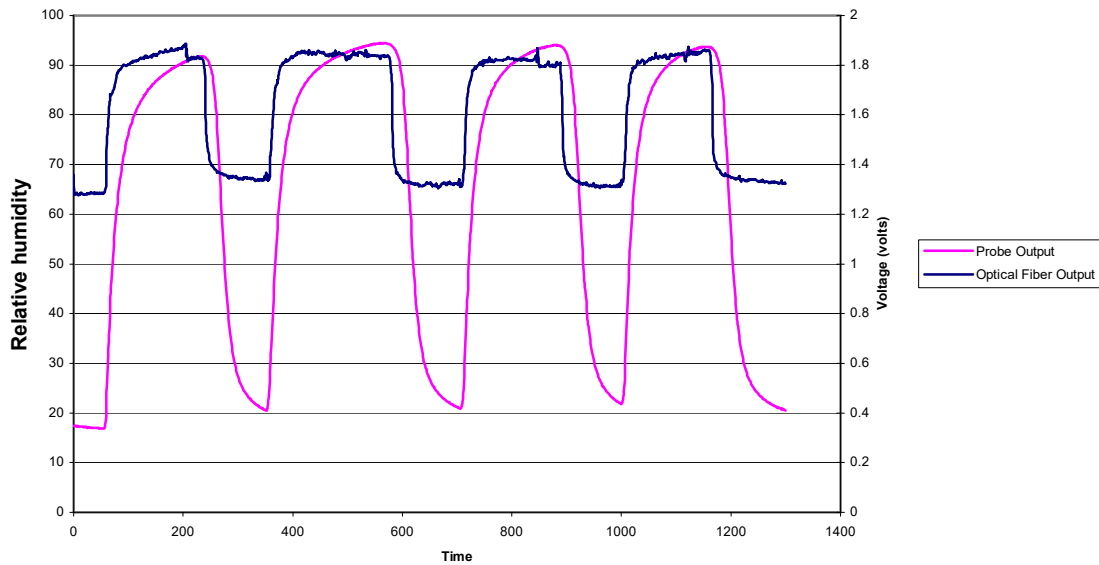

Figure 3.4 Standard probe and Fiber Optic humidity Sensor Response

Another result with the same kind of coating is shown in Figure 3.5, which indicates an increase in the voltage value by a factor of 2 for a change in relative humidity from 45% to 95%.

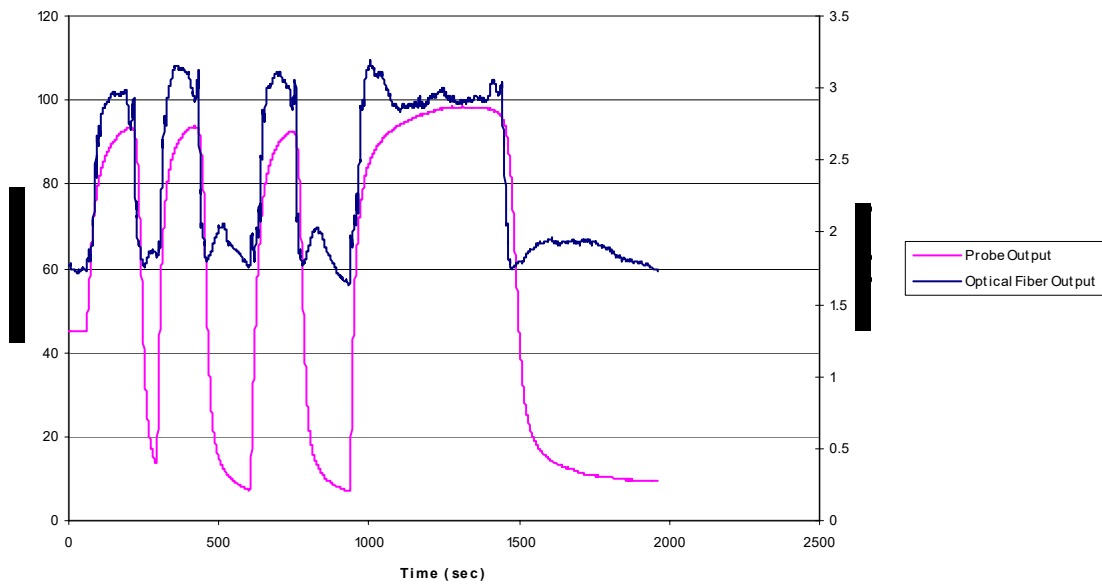

Figure 3.5 Standard probe and Fiber Optic humidity Sensor Response (B)

Results from a similar experiment, shown in Figure 3.6, indicate that the change in the humidity from 39% to 95% produced an equivalent increase in voltage by almost one and a half times.

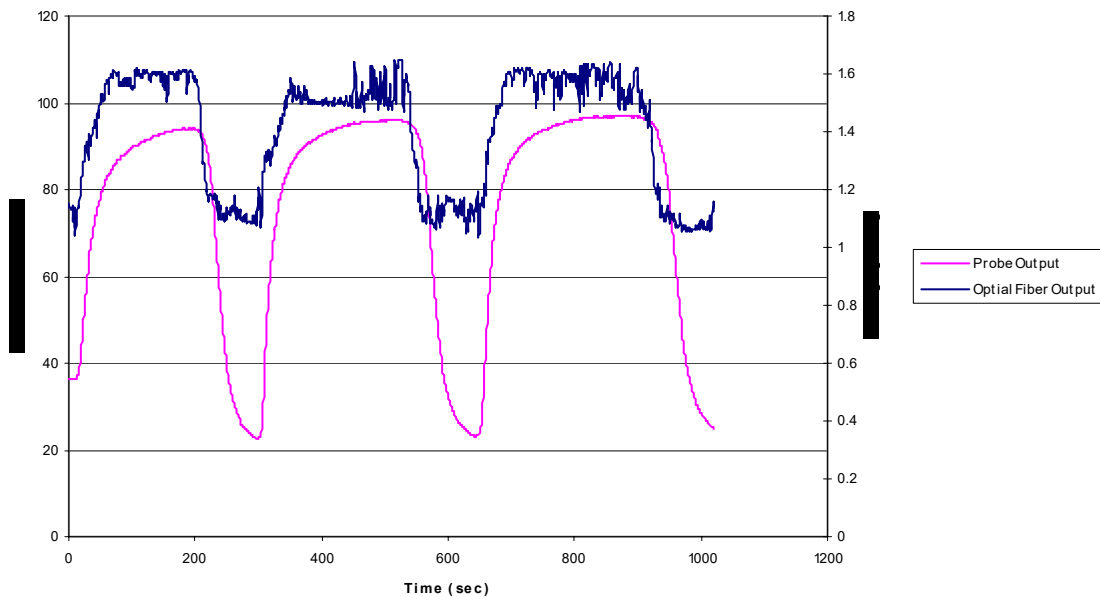

Figure 3.6 Standard probe and Fiber Optic humidity Sensor Response(C)

As can be seen from the plots acquired, the problem in these results is a lack of dynamic range. The differences in the results in Figures 3.4, 3.5 and 3.6 are a result of preparation of the sensor with the same composition of hygroscopic material, at different times. This was due to parameters like polishing of the fiber, coating method, cladding removal method and coupling of the optical fiber to the laser source and photo detector. Even though the response of the sensor is fast in comparison with a standard humidity probe, the voltage range achieved in all the cases considered is relatively small, resulting in difficulties in calibration of the sensor. In addition to that, a change in humidity was obtained in a single step. As a result, the sensor response for the intermediate humidity levels was not revealed. Further experiments were carried out in order to monitor the intermediate response of the sensor for a step change in humidity.

To obtain a step change in humidity on the optical fiber humidity sensor, the set-up of the experiment was changed. In the earlier experiments, the dry air and the humidity were introduced in the climate chamber from two different sources. In other words, the moisture was not controlled by the dry air being introduced in the chamber but was removed by introducing dry air and stopping the flow of moisture in the chamber. In the new set-up, there was only one inlet provided to the chamber, which introduced the moisture in the chamber. The modified set-up is shown in Figure 3.7.

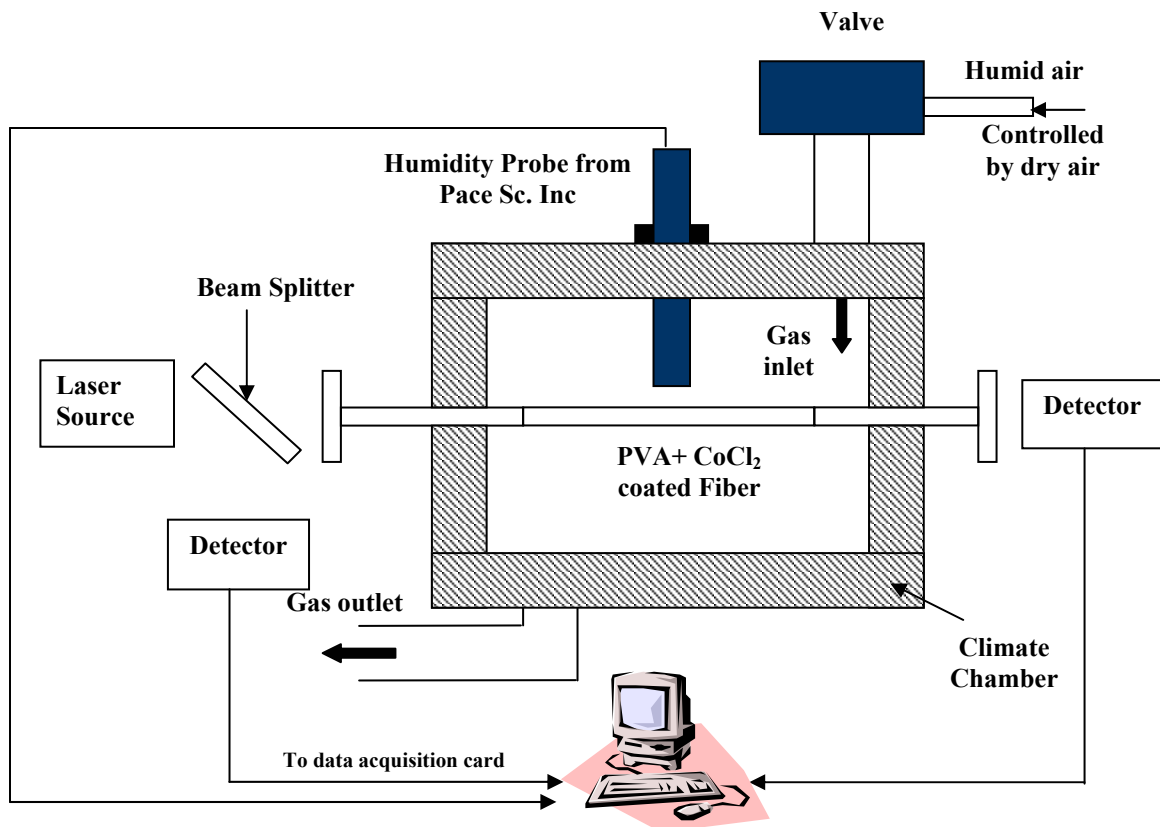

Figure 3.7 Modified Experimental set-up

As can be seen in Figure 3.7, the dry air going in the chamber controls the moisture to be introduced in the chamber, and the humidity is introduced as a

combination of the dry air and the moisture coming out of the nebulizer. The dry air was controlled with the help of a gas flow indicator and controller and was used to achieve the step change in the humidity. After various experiments carried out with this set-up, it was found out that the sensor responds to a relative humidity ranging from 70% to 100%. The results are shown in Figure 3.8.

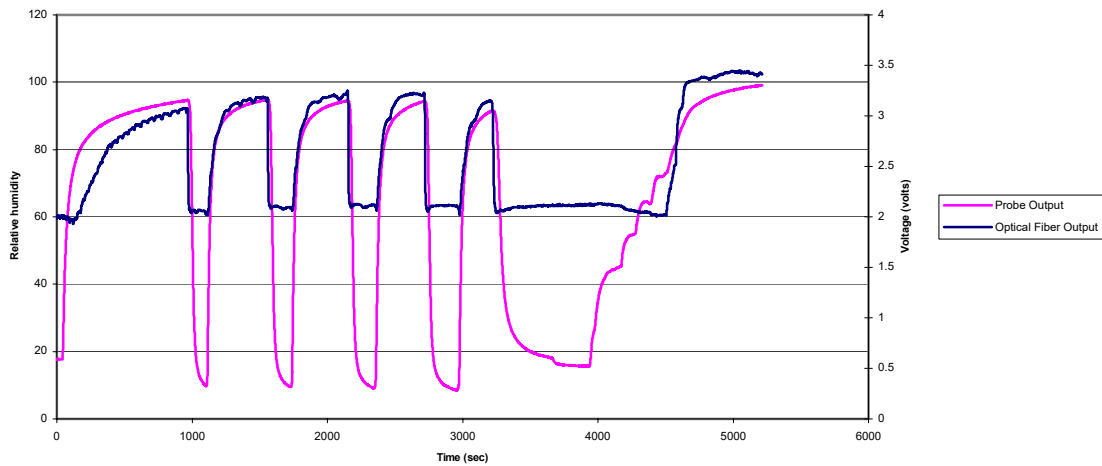

Figure 3.8 Standard probe and Fiber Optic humidity Sensor Response (Modified Set-up)

The plot of Figure 3.8 shows that the sensor performs well when the humidity changes by a considerable amount, whereas when it is increased in steps, the actual response of the sensor can be observed. After reviewing the plot obtained for a step change in the humidity and comparing the output of the optical fiber with standard commercial humidity probe, it was concluded that the response of the sensor to humidity was greater than 70%. This can be seen in the plot shown in Figure 3.9.

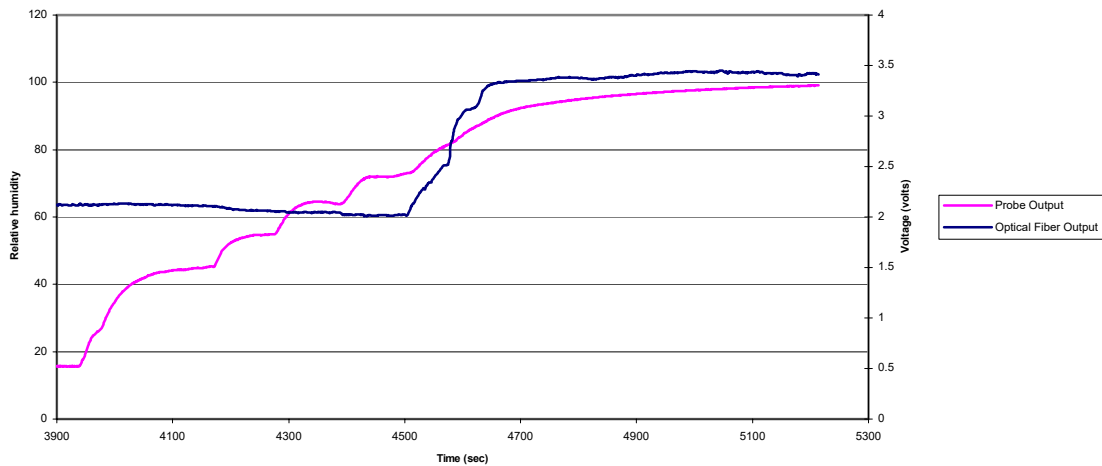

Figure 3.9 Standard probe and Fiber Optic humidity Sensor Response (Step Changes)

This plot clearly shows that the voltage increases only after the humidity has reached a value of 70%. After careful review and study of all the results thus obtained, it was concluded that the cladding removal of the fiber might be the reason why the sensor did not respond to humidity of less than 70%. In all the experimental procedures described, the cladding was removed by dipping the optical fiber in acetone. In order to monitor the response of the optical fiber more carefully, further experiments were carried out. These experiments focused on the behavior of the optical fiber in the presence of moisture after removing the cladding using acetone and by burning, without any deposition on it. The plot in Figure 3.10 shows the behavior of an optical fiber coated with cladding removed by using acetone.

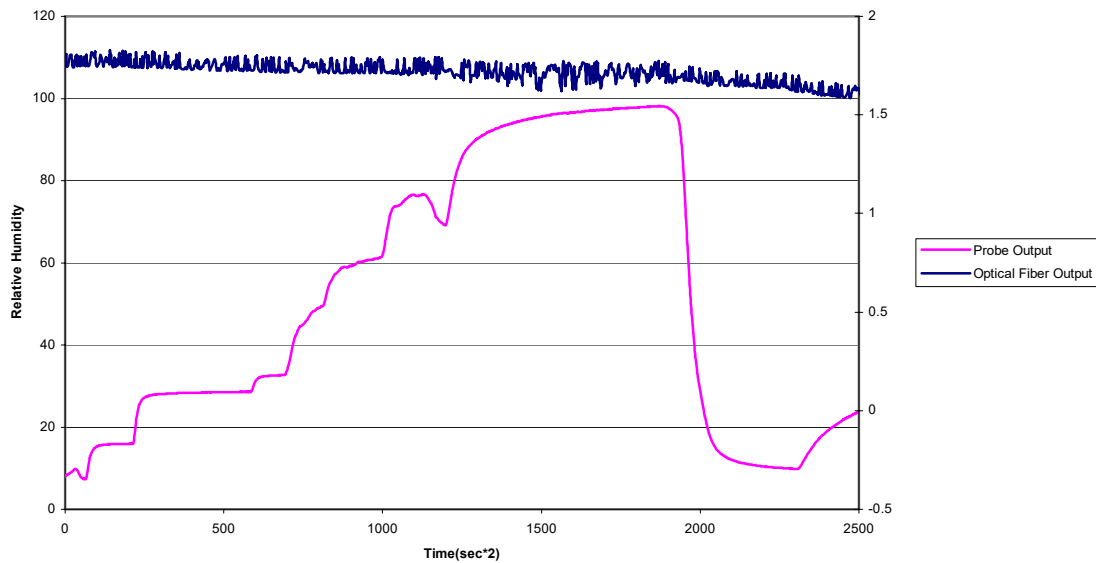

Figure 3.10 Standard probe and Fiber Optic humidity Sensor Response (Cladding removed by acetone- no coats)

It can be seen that as the humidity in the chamber increases (which can also be seen from the trace for the probe output), the optical fiber with the cladding removed by using acetone does not respond to the relative humidity. From this, it was concluded that the optical fiber is not able to interact with the moisture. This further implied that the reason behind it might be that the cladding is not being removed using acetone. Note that the optical fiber was not coated with any hygroscopic material in order to study the interaction of the fiber with the moisture with the two ways of cladding removal.

The response of the fiber with the cladding removed by burning the fiber was monitored next. The results are shown in Figure 3.11.

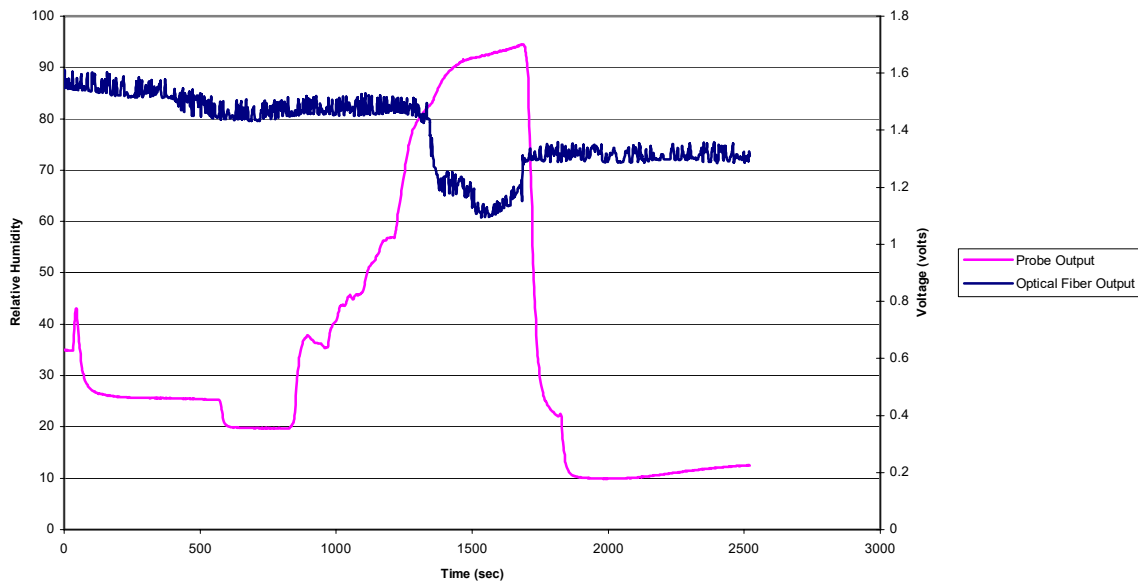

Figure 3.11 Standard probe and Fiber Optic humidity Sensor Response (Cladding removed by burning-no coats)

The plot of Figure 3.11 shows that this optical fiber responds to a relative humidity of more than 80%. This indicated that the optical fiber with the cladding removed by burning has an increased tendency to interact with moisture, whereas the one with cladding removed by using acetone did not. From these results, it was concluded that the cladding was not being removed by dipping the optical fiber in acetone and that it is necessary to remove the cladding by burning the optical fiber. After reviewing these results, it was decided to carry out all further experiments with the cladding removed by burning the optical fiber. The results obtained using this method, shown in Figure 3.12 indicate the response of the sensor with a 2% PVA and 1% CoCl_2 coating and the cladding removal achieved by burning the fiber under a constant propane flame.

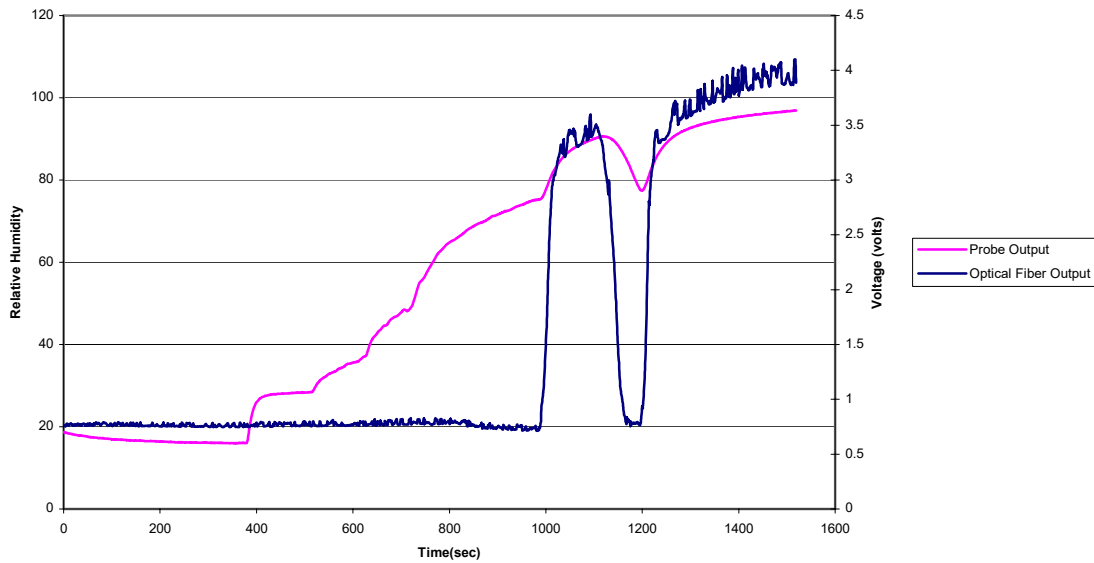

Figure 3.12 Standard probe and Fiber Optic humidity Sensor Response (Cladding removed by burning)

The plot shown in Figure 3.12 indicates that the sensor responds to 75% and higher relative humidity, when a different approach for removing the cladding is adopted. The voltage increase in the optical fiber output achieved in this case is almost twice of what it was before, for a change in humidity from 75% to 95%, approximately. This clearly indicates more interaction of the humidity with the sensor, which results in more absorption of light passing through the fiber and in turn a higher dynamic range. After reviewing the results, it was decided that the coating should be an aqueous solution of PVA and CoCl_2 , and cladding removal had to be done by burning.

3.6 Conclusion

From all the experiments carried out, there were certain procedures that needed to be finalized and standardized for the manufacturing of the final sensor. From the results,

it was clear that acetone evidently did not remove the cladding. The cladding had to be removed by burning, which yielded better results. In order to bring up a cladding-removed, PVA + CoCl₂ deposited, optical fiber humidity sensor, a sensor was designed and fabricated that reacted to relative humidity as low as 75% with a coat of an aqueous solution of PVA and CoCl₂. The cladding removal was decided to be done by burning as a standard procedure for further research and development. This kind of sensor provides a response dynamic range of 0.8V to 4.0V for a relative humidity change from 75% to 95%. The key development details and specifications of the finalized sensor using the chemical deposition phenomena are tabulated in Table 3.1.

Table 3.1
Key development details and specifications of the sensor

Working Principle	Based on evanescent tail absorption of the light passing through a unclad-chemically deposited-optical-fiber, due to change in relative humidity, resulting in change in the light intensity, which in turn changes the light detector output (voltage).
Cladding removal	Removing the jacket of the optical fiber and then burning the fiber under a constant propane flame.
Optical Fiber used	200- μ m
Light source	Diode Laser, wavelength = 650nm (\pm 50nm)
Light Detector	Photodiode
Dynamic Range (V)	0.8V to 4.0V
Relative Humidity Range (%RH)	75% to 95%
Data Acquisition System	Data Acquisition card: Computerboards Data Acquisition Program: programmed in Labview, version 4.0 (Refer to Appendix A)
Sensor	

CHAPTER IV

CURRENT DEVELOPMENTS AND FUTURE WORK

4.1 Introduction

A chemically deposited optical fiber humidity sensor was successfully implemented with a dynamic range of approximately 60% to 100%. This type of implementation is called a “straight probe optical fiber” implementation. In this type, the chemical deposition of PVA + CoCl₂ was applied on an optical fiber after removing the cladding by burning. Various experiments were carried out in order to come up with an ideal response of the sensor to the change in humidity. After a careful study of the sensor implemented and possible future developments, a need for a more sensitive and wide range sensor was aroused. This chapter summarizes the future work that can be carried out, as well as the current research being carried out at the Diagnostic Instrumentation and Analysis Laboratory (DIAL), Mississippi State University, on this project.

4.2 U-shaped Sensing Probe Optical Fiber Humidity Sensor

In order to increase the dynamic range and the sensitivity of the sensor, a u-shaped (bent) probe approach was adopted. [14, 20] This section discusses the theory, advantages, and implementation of the u-shaped sensing probe optical fiber humidity sensor.

4.3 Theory

As explained in Sec.3.2, the straight probe optical fiber humidity sensor works on the evanescent tail absorption phenomenon. It is based on the absorption of the light passing through the optical fiber at the sensor region (chemical deposition area/unclad portion of the fiber), depending on the interaction of evanescent tail of the light with the core-cladding interface of the optical fiber. In order to increase the sensitivity of the sensor, it is necessary to increase the amount of absorption of light in the optical fiber at the sensitive region (core-cladding interface with the chemical deposition). To obtain maximum absorption, the interaction of the evanescent tail of light with the core-cladding interface should be as high as possible. The method to achieve this and the comparison of the bent probe (u-shaped) with the straight probe are further discussed in section 4.3 of this chapter. Figure 4.1 shows the straight probe optical fiber humidity sensor and the path of light through it.

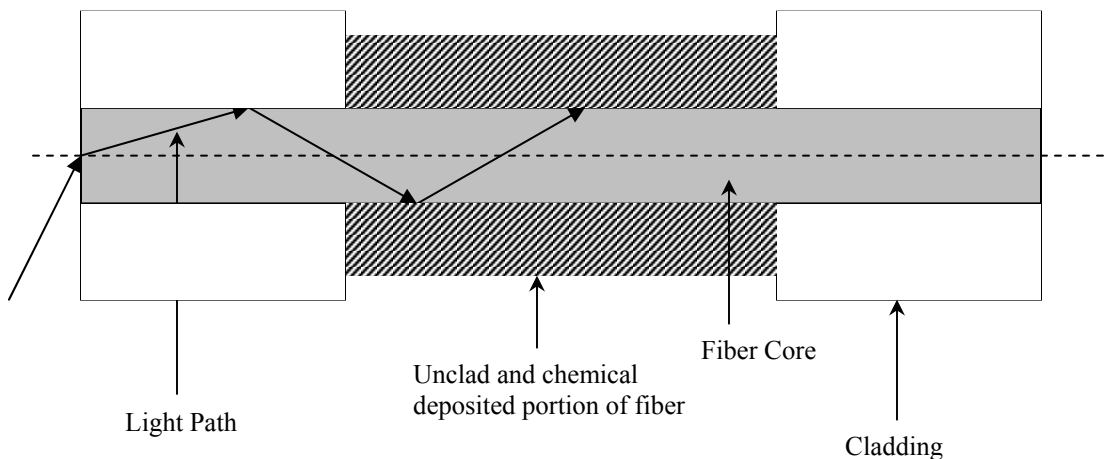

Figure 4.1 Straight Probe Sensor, Light Path and Its Interaction With the Core-cladding Interface.

It can be clearly seen that the interaction of the light passing through the optical fiber with the core-cladding interface is limited. Hence, the absorption of the evanescent tail of the light in the sensor region (unclad and chemical deposited portion) is less, which makes the sensor less sensitive [20]. As discussed earlier, an increase in the interaction of the light propagating through the fiber with the core-cladding interface will consequently increase the sensitivity of the sensor. An increase in the number of internal reflections in the fiber will eventually increase the interaction of the light at the sensor region [20]. A bent (u-shaped) probe has proven to be more sensitive to changes in humidity. [14, 20] The u-shaped probe, light propagation path through it, and the interaction with the unclad chemical deposited area are shown in Figure 4.2. This figure shows how the interaction of the light can be increased, which further leads to more absorption of the evanescent tail of light at the sensor region.

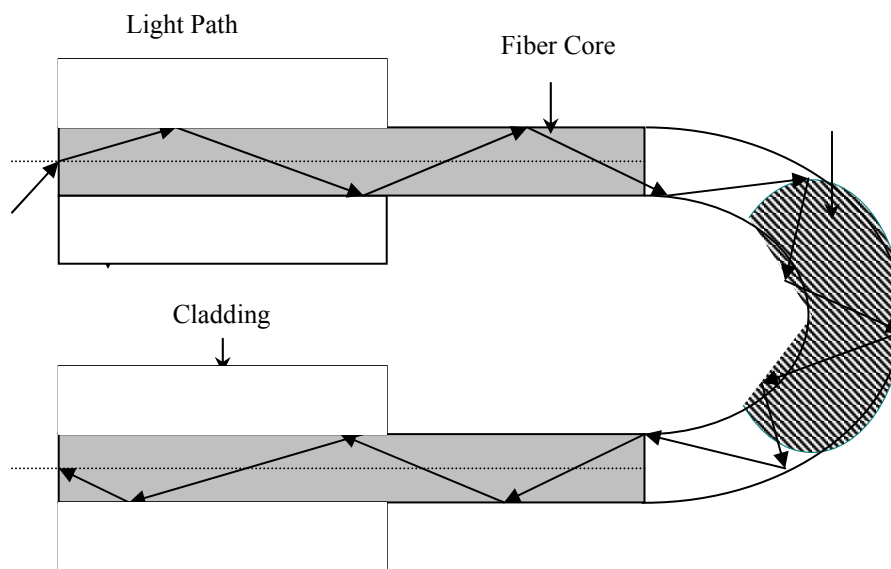

Figure 4.2 U-shaped (bent) Probe Sensor, Light Path and Its Interaction with the Core-cladding Interface.

4.4 U-shaped Sensor Probe Implementation and Current Development

A U-shaped optical fiber sensor probe was implemented as a continuation of the straight probe optical fiber. A bent probe was created by heating the exposed (jacket removed) portion of the optical fiber and slowly bending it. The bending of the fiber showed drastic change in the behavior of the sensor [21]. The sensor responded to humidity from 3% to 90%. Figure 4.3 shows a bent probe created.



Figure 4.3: The implemented U-shaped (bent) Probe Sensor

Figure 4.4 shows the response of the u-shaped (bent) probe and its comparison with a commercially available standard humidity probe. The result shows that the bent probe yields a higher dynamic range and sensitivity over the straight probe.

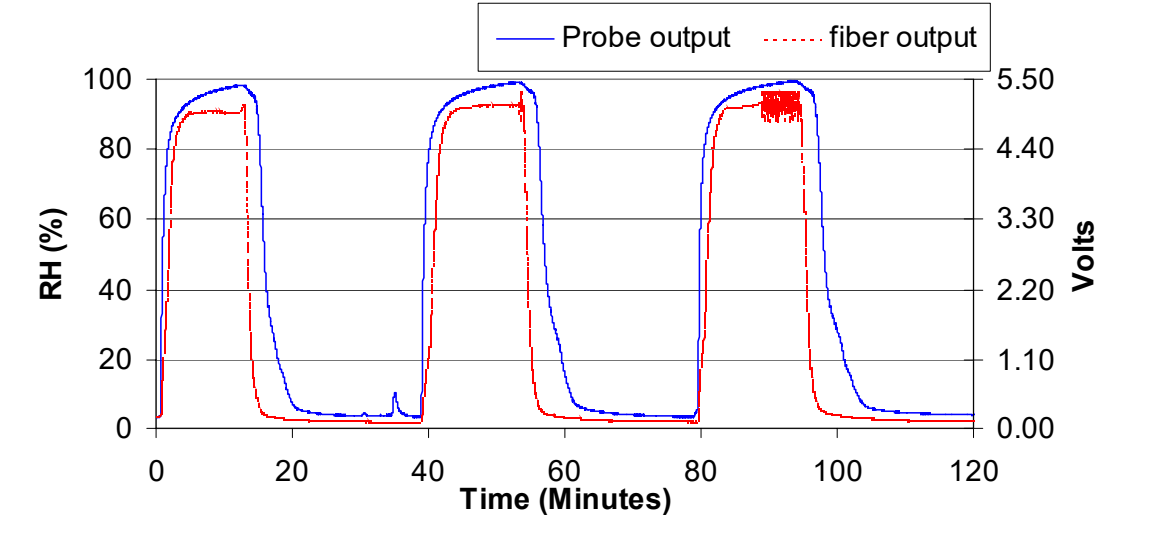

Figure 4.4: Standard probe and bent probe humidity sensor response

Further research on this project is going on at the DIAL, Mississippi State University, which includes optimization of the bending diameter and coating method and attempts to create a consistent and reliable bent probe (u-shaped) humidity sensor. Also, efforts are underway to create a commercial, robust, fast responsive and highly repeatable humidity probe based on the evanescent absorption phenomena of an “unclad-chemically deposited-optical fiber”.

4.5 Acknowledgement

This research work, carried out at the Diagnostic instrumentation and Analysis Laboratory, was supported by the Department of Energy (DOE) cooperative agreement No. DE-FC26-98FT40395.

REFERENCES

- [1] M. Scott *et. al.* A guide to Measurement and Humidity Handbook, National Physical Laboratory-Institute of Measurement and Control, Crown Publishers, London (1996).
- [2] Bernard M. Kulwicksi, “Humidity Sensors”, Journal of the American Ceramic Society, Vol. 74, 697-708 (1991)
- [3] Robert E. Ruskin, “Humidity and Moisture: Measurement and Control in Science and Industry, Vol. 1: Principles and methods of measuring humidity”, Reinhold Publishing Corporation, New York, pp. 346, pp. 365 (1963)
- [4] Bosak, S.V. “*Science is...: A source book of fascinating facts, projects and activities*”, Scholastic Canada Ltd., pp. 444 (1992).
- [5] Hiromi Shimizu, Hiroki Matsumoto, Masahiro Asakura and Kenzo Watanabe, “A Digital Hygrometer”, IEEE Transactions on Instrumentation and Measurement, Volume: 37, Issue: 2, pp.300-304 (1988).
- [6] Uksong Kang and Kensall D. Wise, “High-Speed capacitive Humidity sensor with on chip thermal reset”, IEEE Transactions on Electronic Devices, Vol. 47, No. 4 (2000).
- [7] Don-Hee Lee, Hyung-Ki Hong, Chil-Keun Park, Geun Ho Kim, Young Sam Jeon, Jong Uk Bu, The 14th IEEE International Conference on Micro Electro Mechanical Systems (MEMS), pp. 558-561 (2001).
- [8] K. T. V. Grattan and Dr. T. Sun, “Fiber optic sensor technology: an overview”, Elsevier Science, Sensors and Actuators 82, pp. 40-61 (2000)
- [9] Eric Udd, “Fiber Optic and Laser Sensors”, SPIE-International Society for Optical Engineering (1986).
- [10] A Selvarajan, “Fiber optic sensors and their applications”, Department of Electrical and Communication Engineering, Indian Institute of Science.
- [11] Arya V, Murphy K.A, Wang A, Claus R.O, “Micro bend Losses in Single mode Optical Fibers: theoretical and experimental investigation”, Journal of Lightwave Technology, Vol. 13, Issue:10, pp. 1998-2002 (1995).
- [12] A MacLean, W Craig Michie, S G Pierce, G Thursby, B Culshaw, C Moran, N B Graham, “Hydro-gel/Fiber Optic Sensor for Distributed Measurement of Humidity and pH Value”, SPIE Vol. 3330 (1998).

[13] Roland S. Young, "Cobalt: It's Chemistry, Metallurgy and Uses", Reinhold Publishing Corporation, New York (1906).

[14] Soichi Otsuki, Kimihiro Adachi, Takahisa Taguchi "A novel fiber optic gas sensing configuration using extremely curved optical fibers and an attempt for optical humidity detection", Elsevier Science, Sensors and Actuators B-53, pp. 91-96 (1998).

[15] Quan Zhou, Mahmoud R. Shahriari, David Kritz and George H. Sigel, "Porous Fiber Optic Sensor for High-sensitivity Humidity Measurements", American Chemical Society, Analytical Chemistry Vol. 60, No. 20, pp.2317-2320 (1989).

[16] Corera F. P, Gaston A, Sevilla J, "Relative humidity sensor based on the side-polished fiber optic", IEEE Proceedings of the 17th Instrumentation and Measurement Technology Conference (IMTC), Vol. 1, pp. 17-22 (2000).

[17] Ryszard Hypszer and Henryk J. Wierzba, "Fiber Optic for relative humidity sensors", SPIE Vol. 3054, pp. 145-150 (1997).

[18] A. P. Russell and K. S. Fletcher, "Optical sensor for the determination of moisture, Foxboro Company", Analytica Chimica Acta 170, Elsevier Science Publishers B.V, Amsterdam, pp. 209-216 (1985).

[19] Jagdish P. Singh, Krishnan Balasubramaniam, Alexander Parfenov and Robin Wisner, "Optical Fiber Sensors and Their Applications", Diagnostic Instrumentation and Analysis Laboratory, Mississippi State University, [1999]

[20] S.K. Khijwania and B. D. Gupta, "Fiber Optic Evanescent Field Absorption Sensor: Effect of Fiber Parameters and Geometry of the Probe", Optical Quantum Electron., Vol. 31, pp. 625-636 (1999)

[21] Rajeev Jindal, Shiquan Tao, Jagdish P. Singh, Parikshit Gaikwad, "High Dynamic Range Fiber Optic Humidity Sensor", Society for Photo-Optical Instrumentation Engineers (SPIE), Optical Engineering Vol. 41(5), pp.1093-1096 (2002)

APPENDIX A

GRAPHICAL USER INTERFACE FOR THE PC-BASED ONLINE DATA ACQUISITION SYSTEM IN LABVIEW

A.1 Front Panel (Labview Version 4.0)

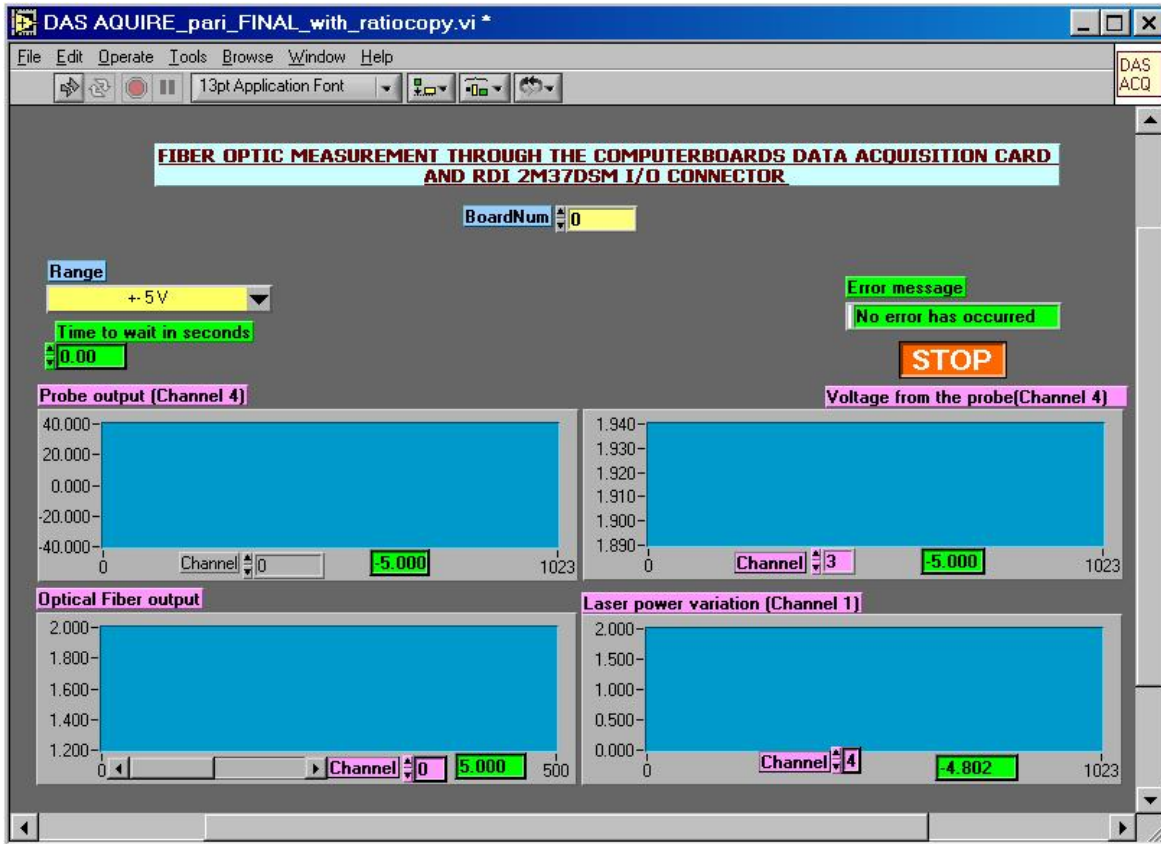

A.2 Example Diagrams (Source)

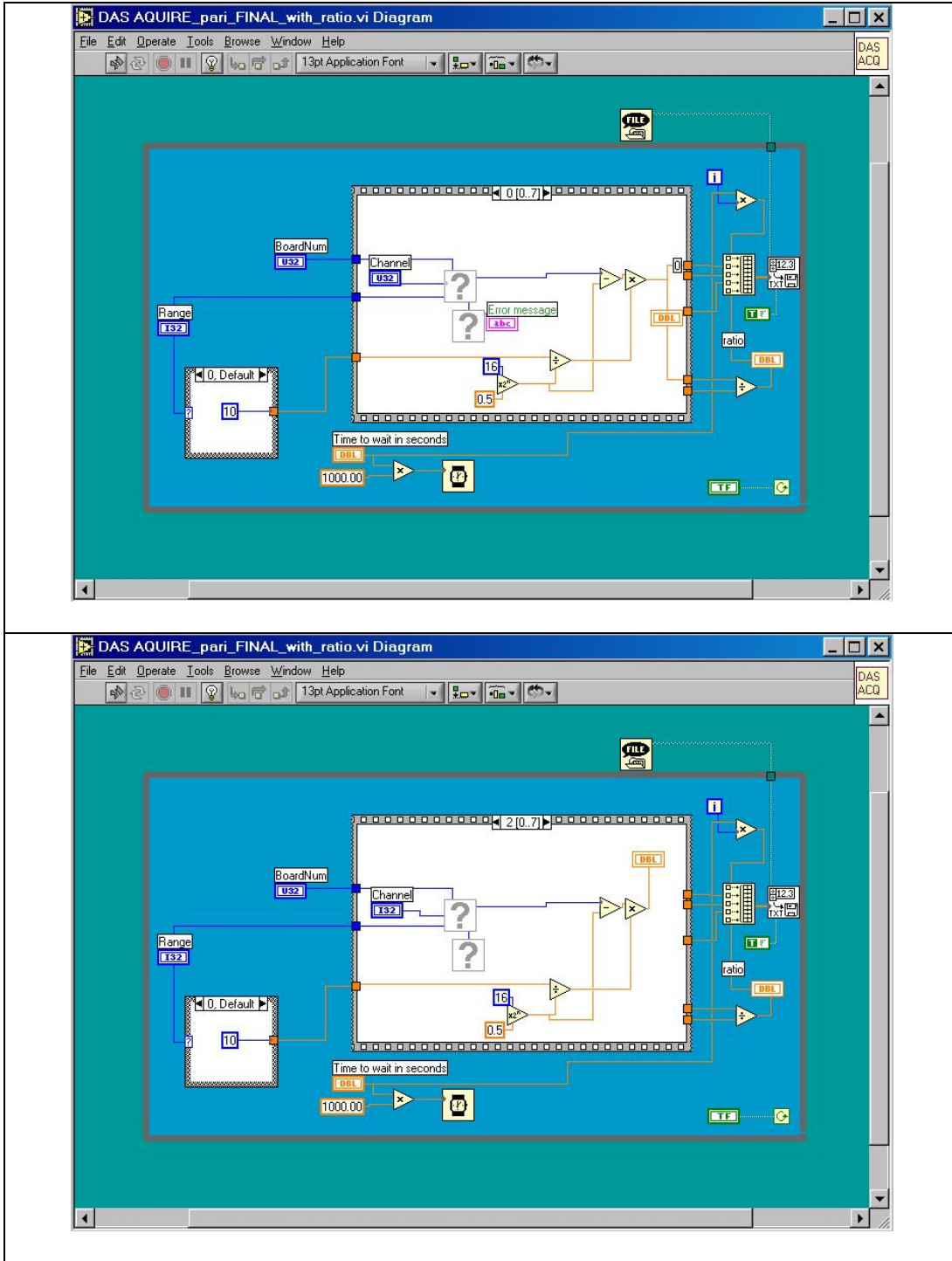

APPENDIX B
OPTICAL FIBER POLISHING METHOD

B.1 Preparing the Optical Fiber (OF)

1. After determining the desired length, the fiber is measured and the spool is cutoff with the cutting tool.
2. The cutting is the most important part and therefore must be done with precision. The part of the fiber being cut is slightly wet, after which the blade is to just touch the desired cutting spot with a half break. The fiber is broken by complete bending, which causes a clean break.

B.2 Polishing the fiber

1. The glass top and polishing paper set is used for hand polishing.
2. The gray is used first, then the pink, and finally the white polishing paper.
3. The connector is logically put into the metal holder.
4. The polishing paper (gray first) is placed on top of the glass counter and sprayed well with de-ionized water.
5. The metal holder is placed on the paper and then turned in a figure “8” pattern with fingers on either side of the connector.
6. Do this for about four or five minutes (until there is no more visible glue on the connector end) and then switch to the pink paper.
7. Perform the same figure “8” pattern until the end starts shining (about 3 or 4 minutes).
8. Now use the white paper until the end is shining well and polished.